



CITY

60132



 LEGO.com/city



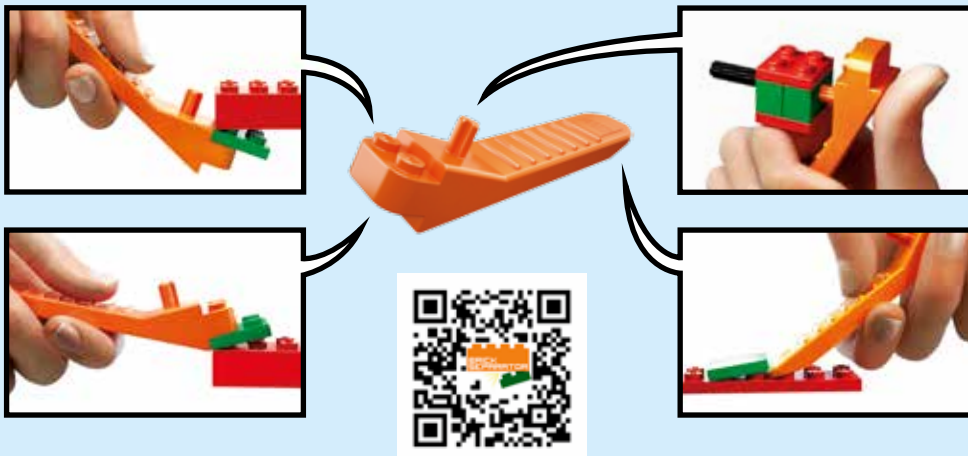
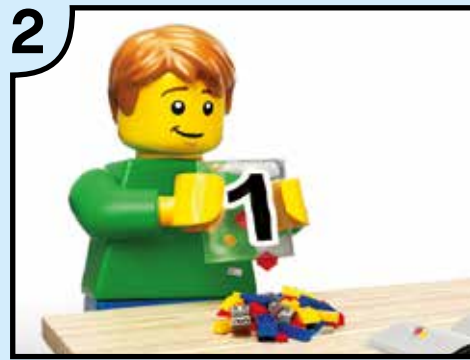

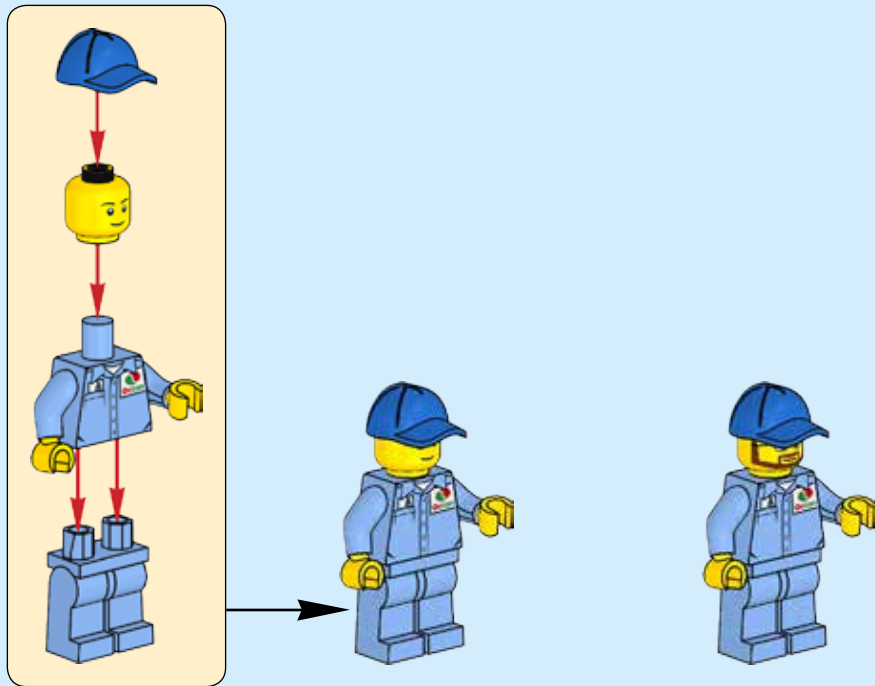

1

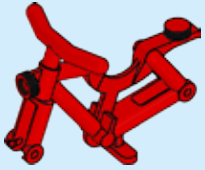

2

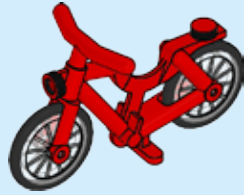

3

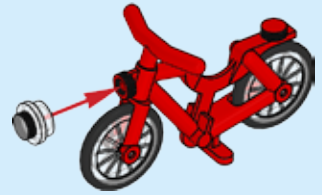



1x

1

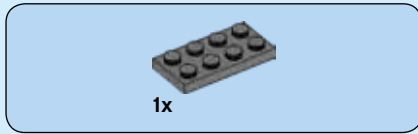

1x

2





2x



2x

3

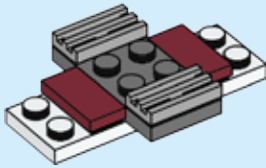

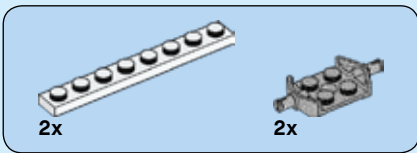

4

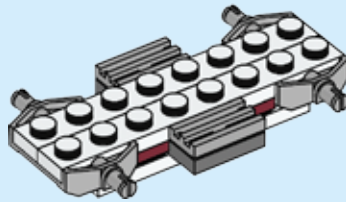
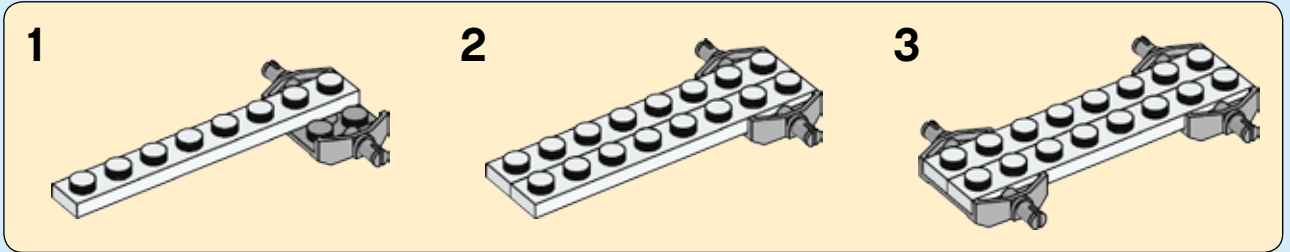



1x



1x

5

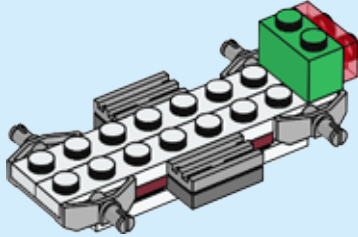
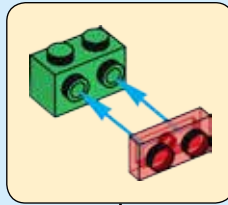



1x



1x

6

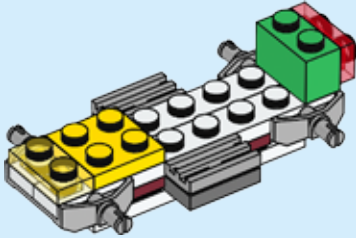

2x



2x

7

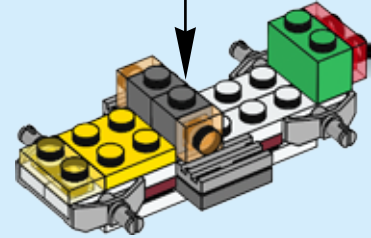
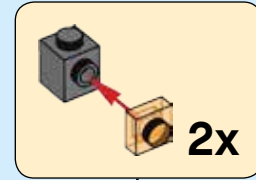



1x



1x

8

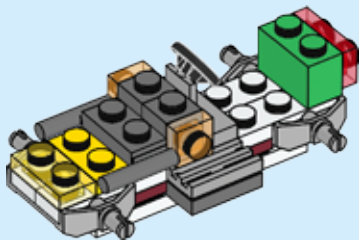

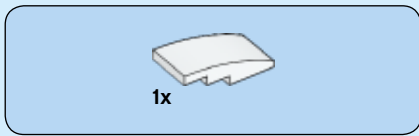

9

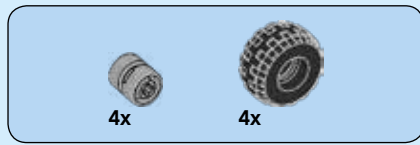
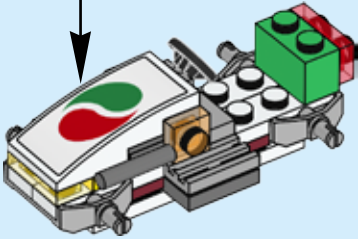
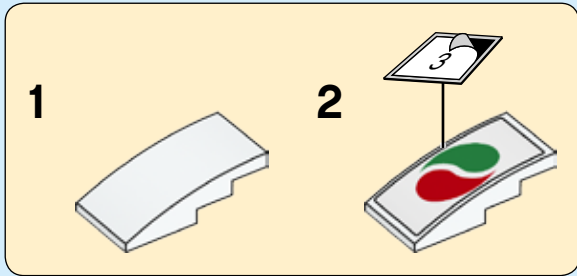

10

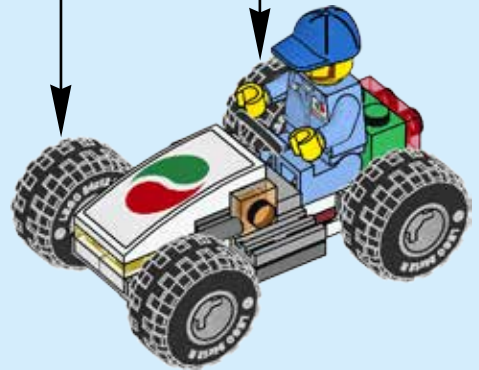
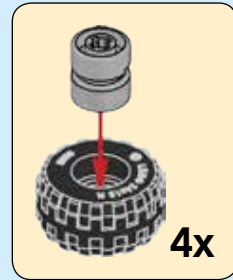

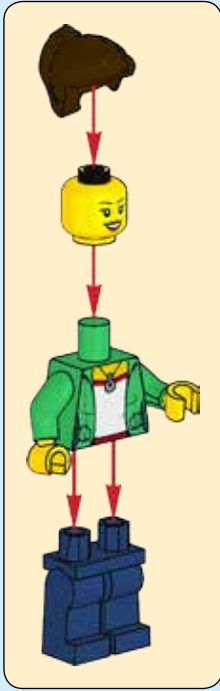

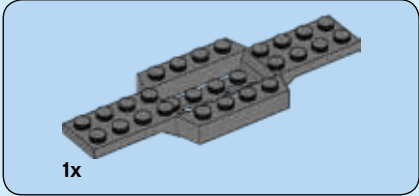

1

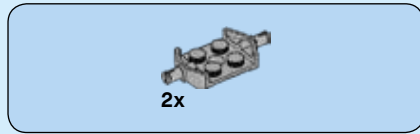
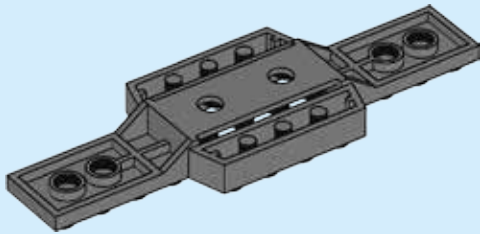

2

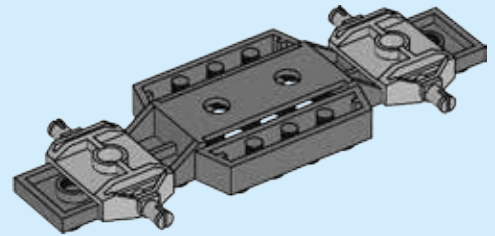



2x

3

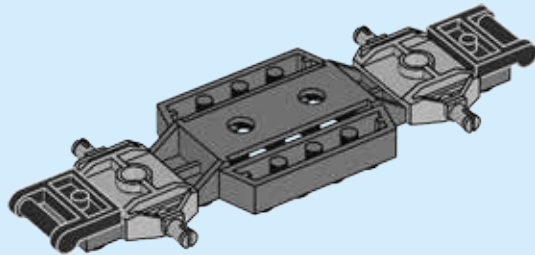



4

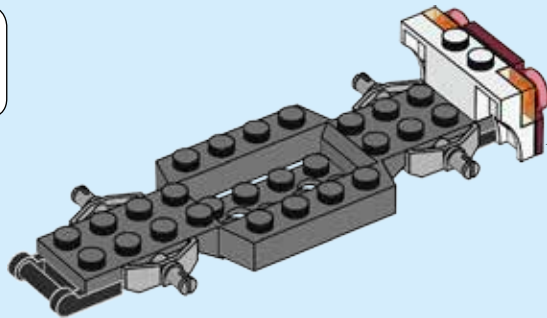
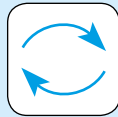
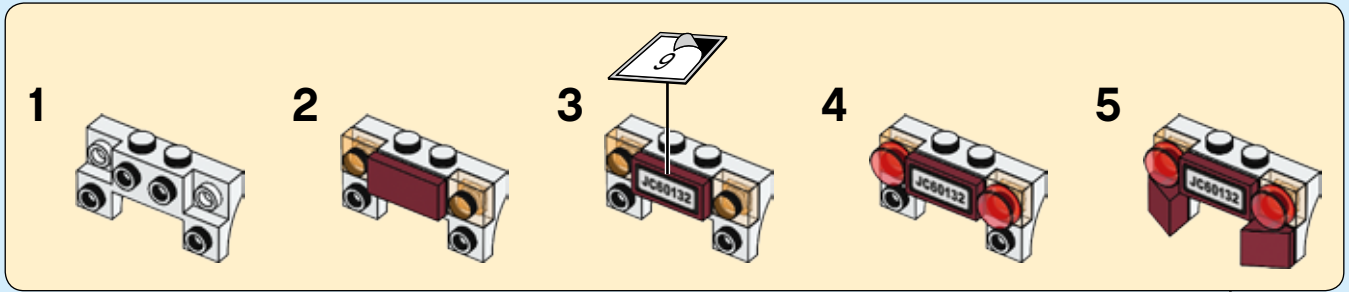

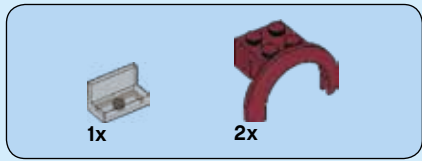

5

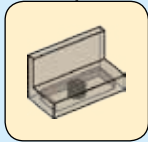
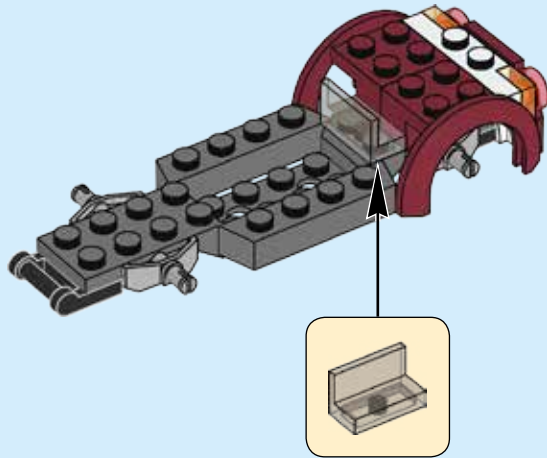



1x



1x

6

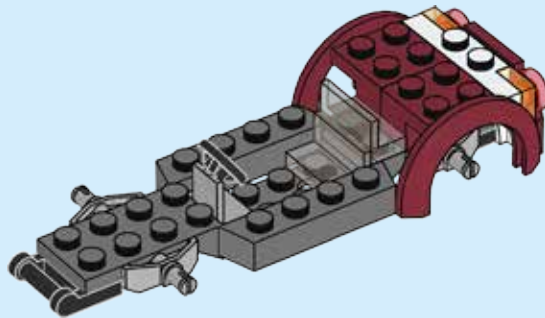

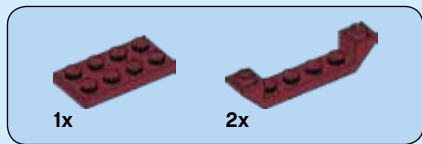

7

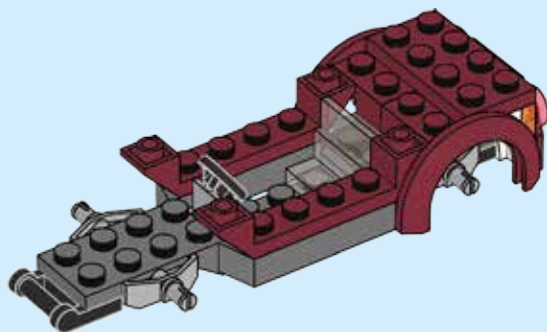

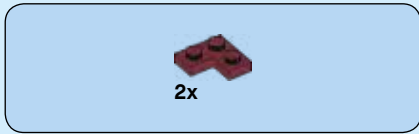

8

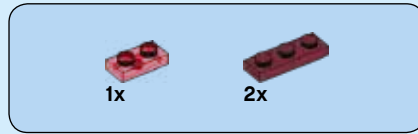
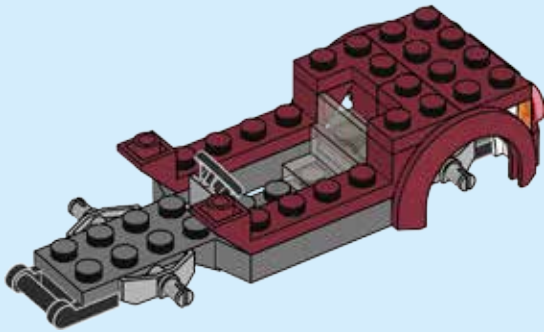

9

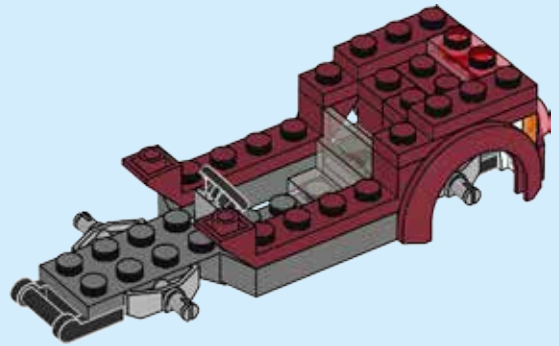



1x



1x

10

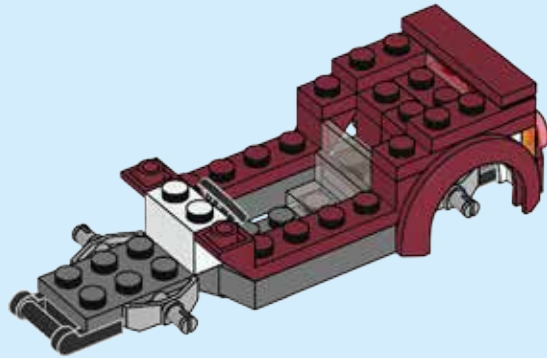

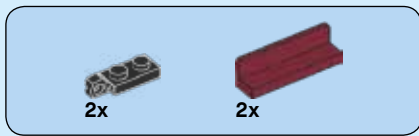

11

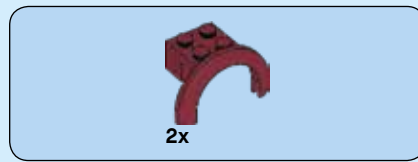
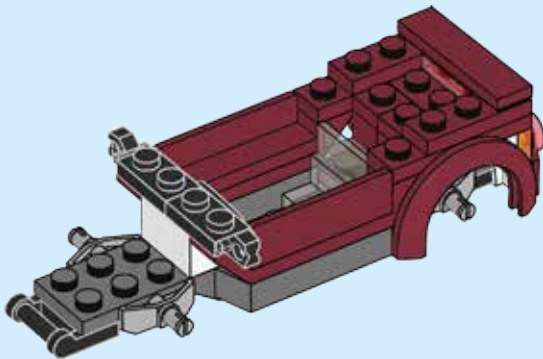

12

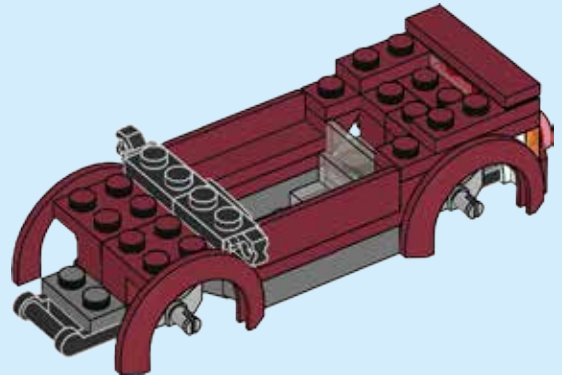

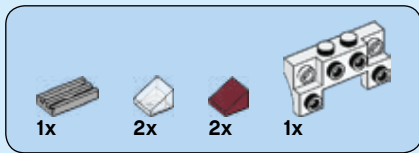

13

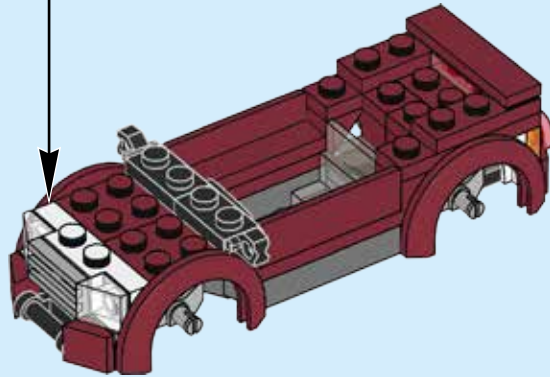
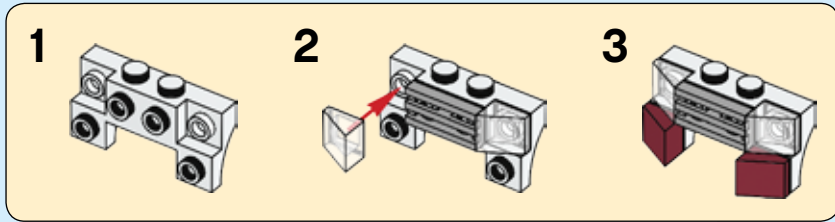

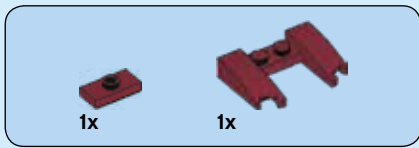

14

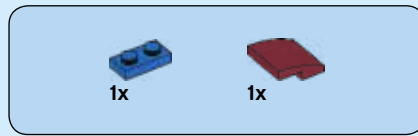
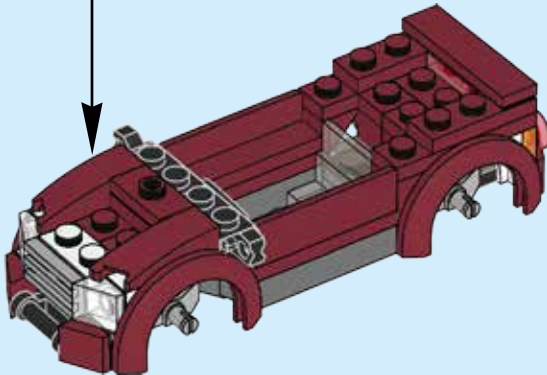
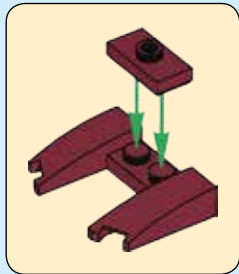

15

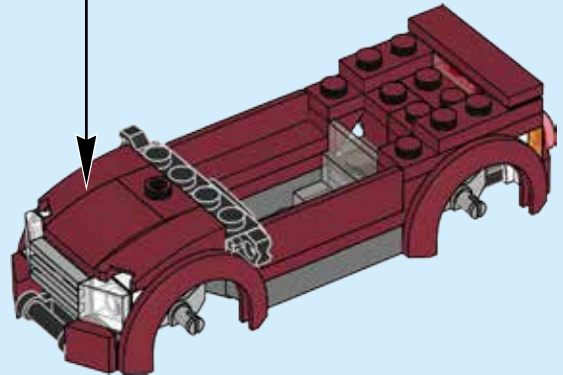
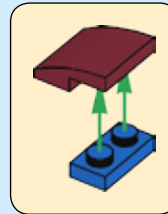

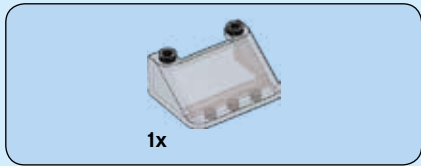

16

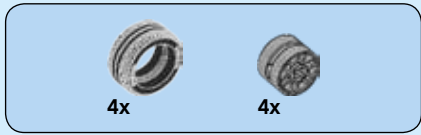
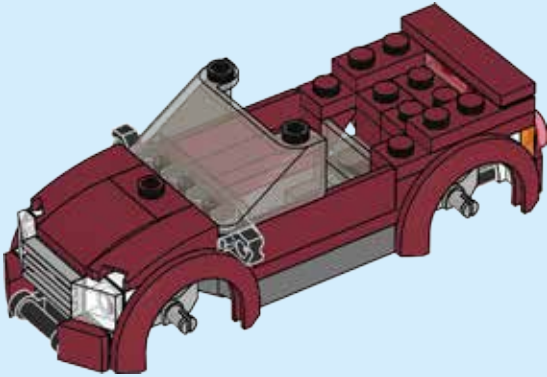

17

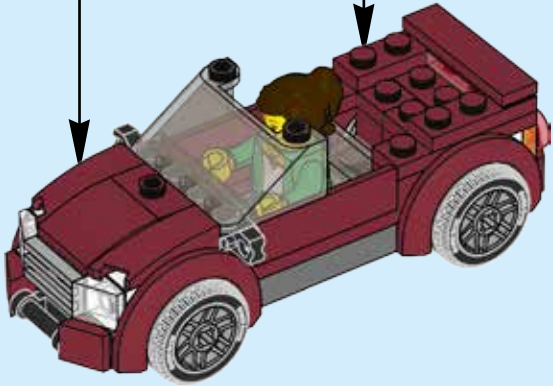
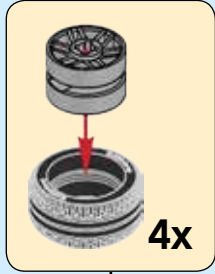

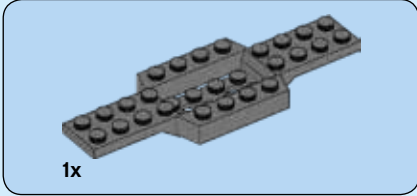
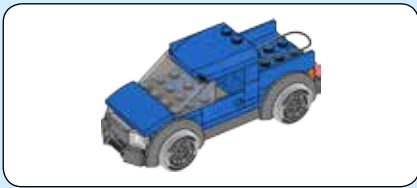

1

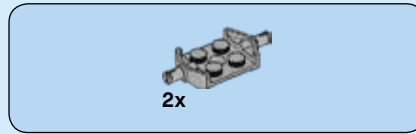
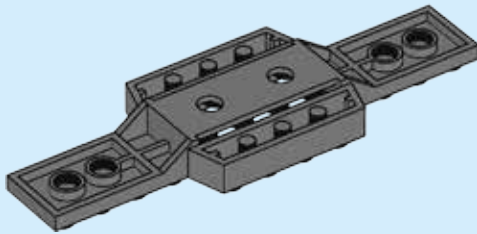

2

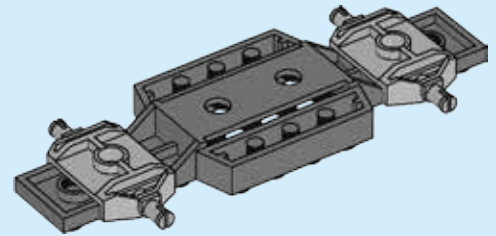



1x

3

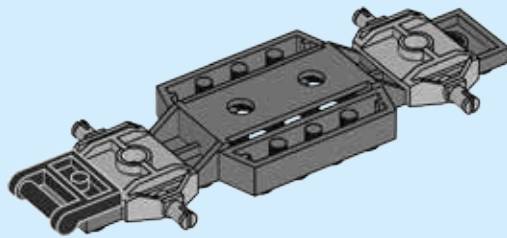

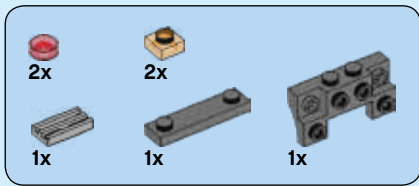

4

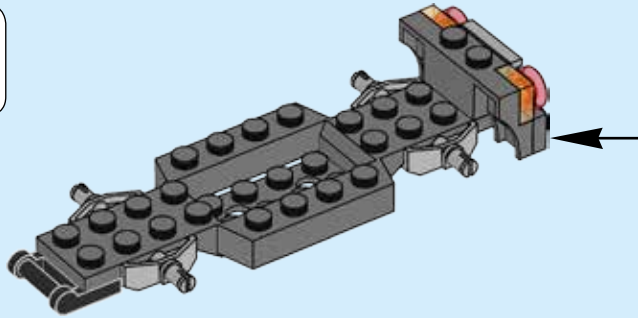
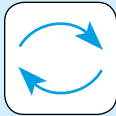
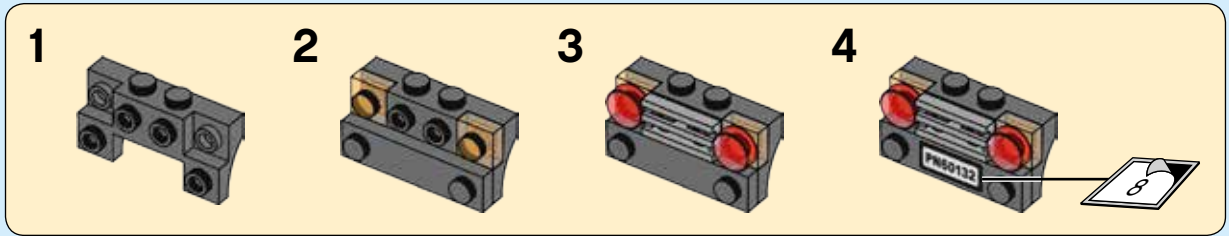



2x

5

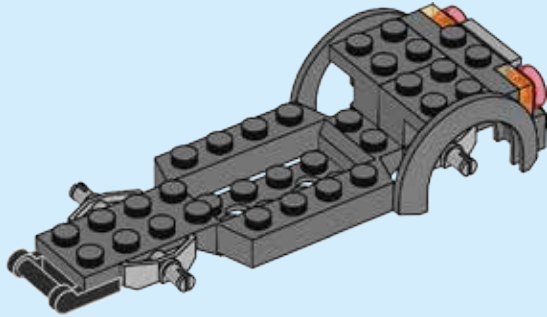



1x



1x

6

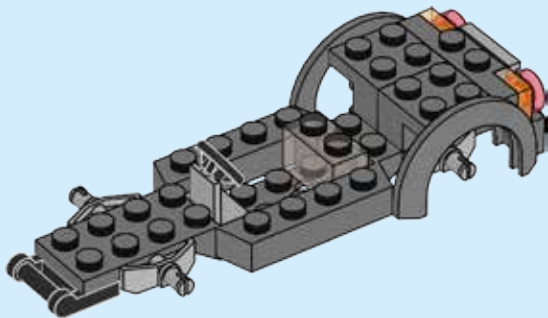

2x

7

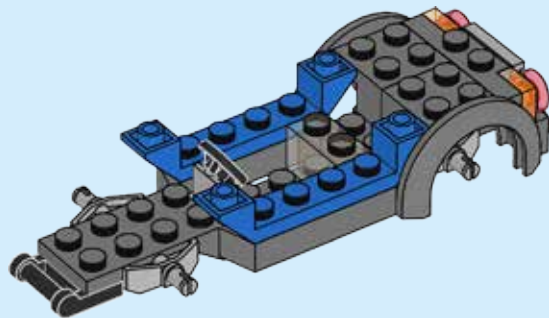

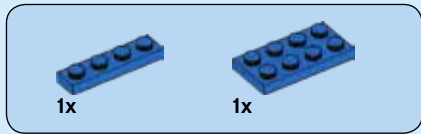

8

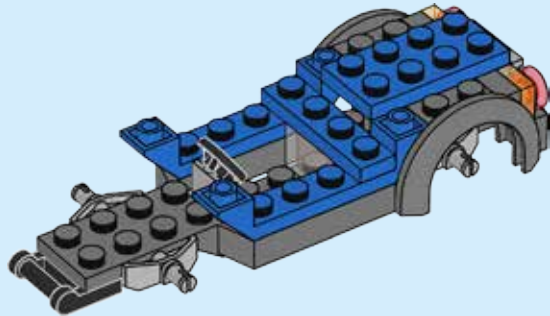

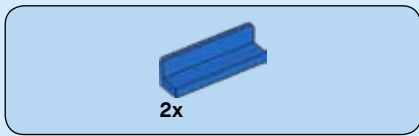

9

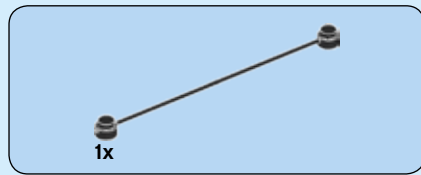
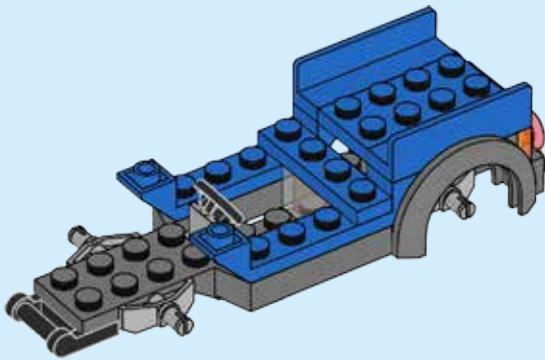

10

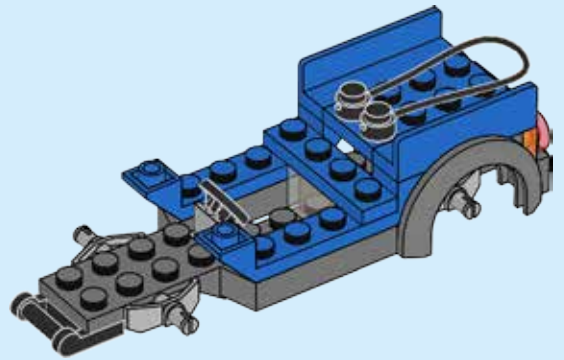



2x



1x



1x

11

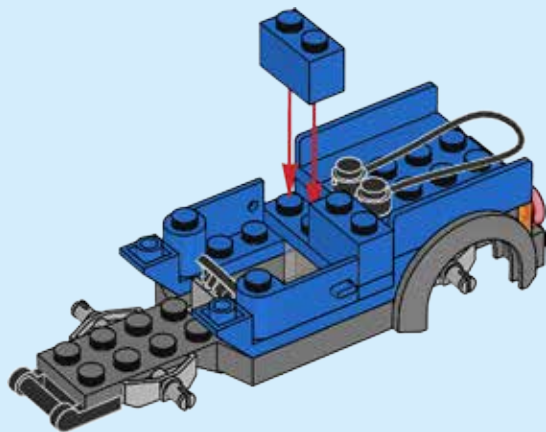

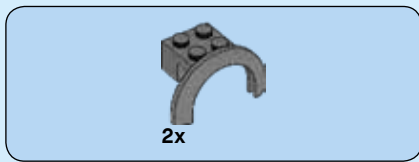

12

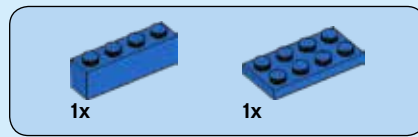
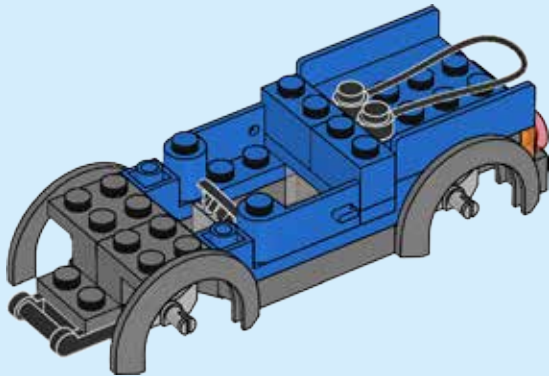

13

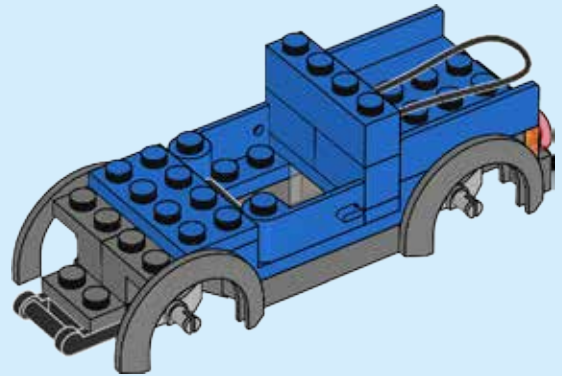



14

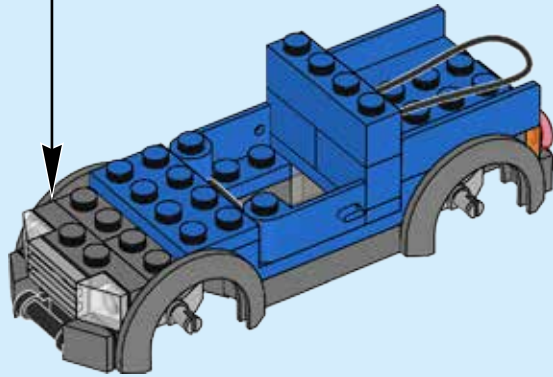
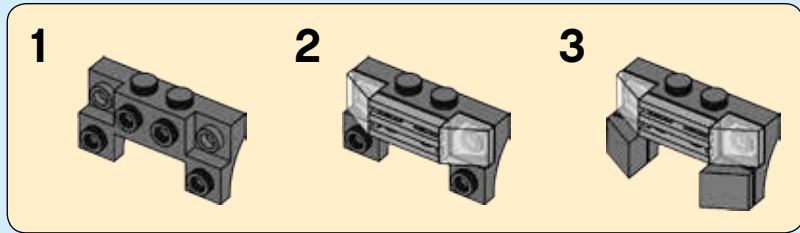

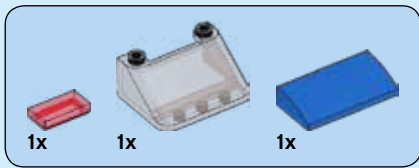

15

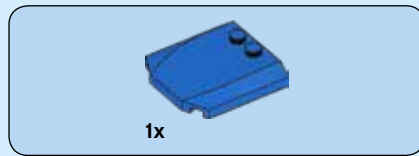
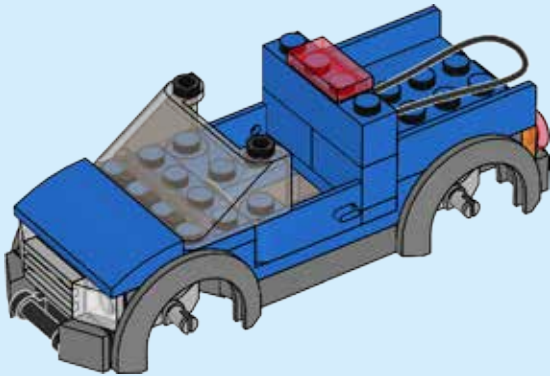

16

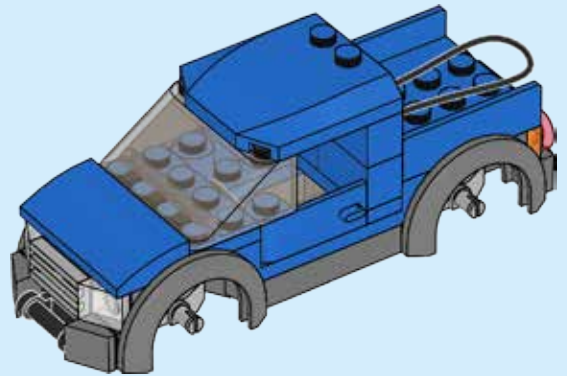



17

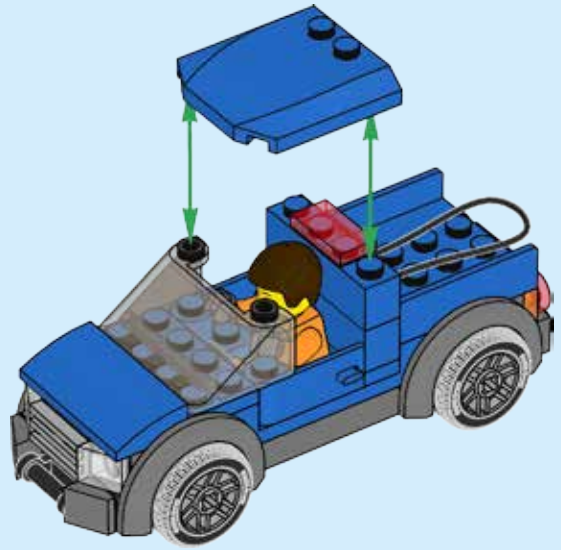
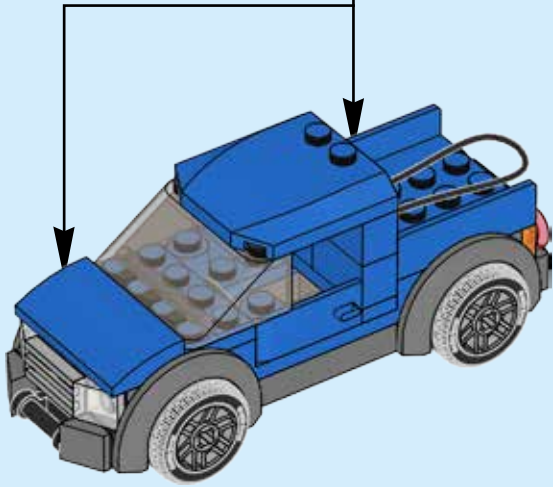
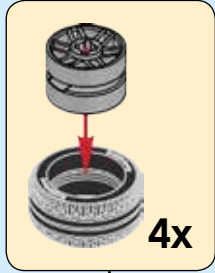

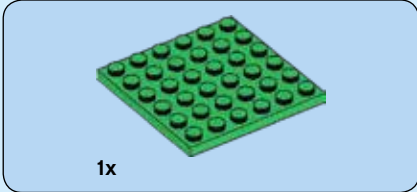

1x

1

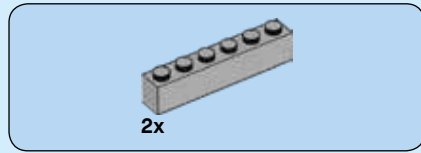
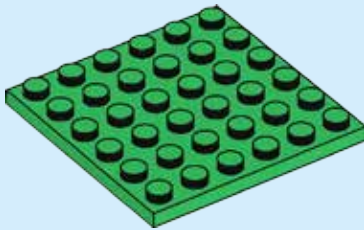

2x

2

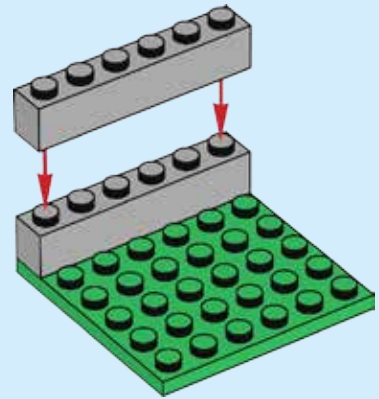

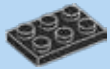

1x



3x

3

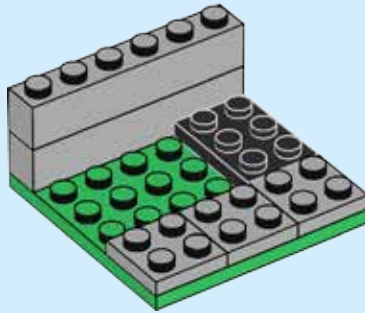



4

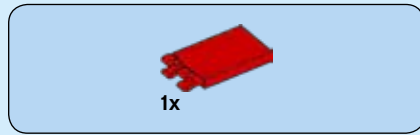
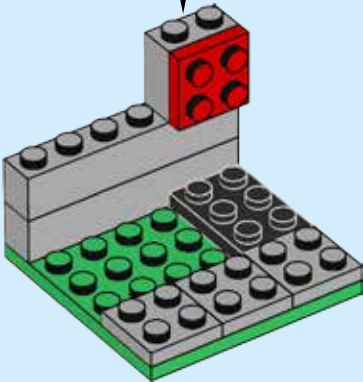
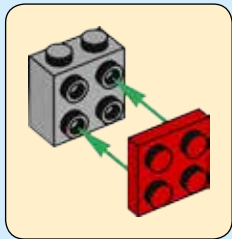

5

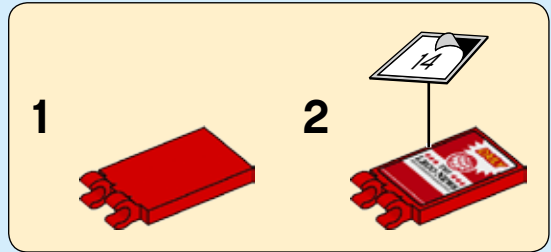

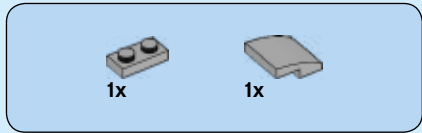

6

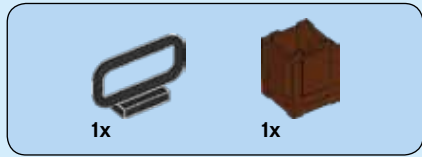
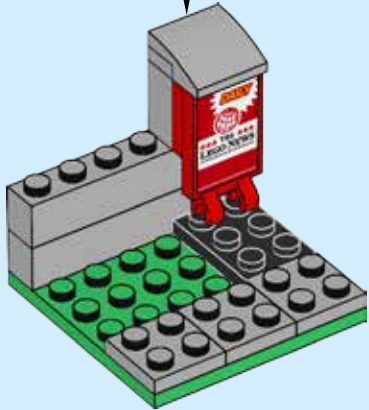
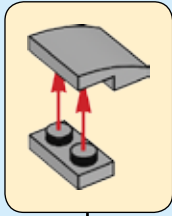

7

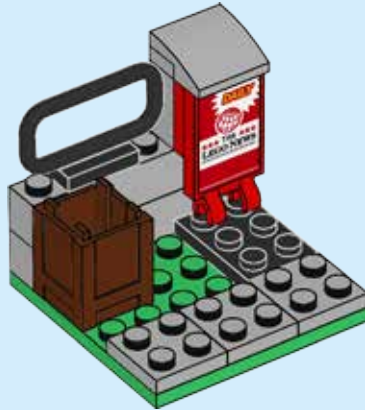

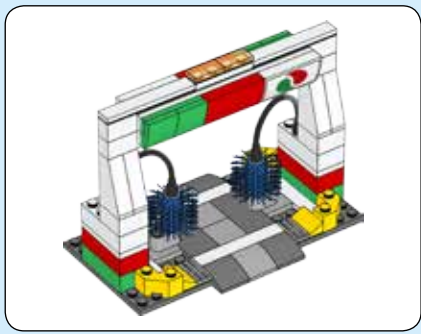

1

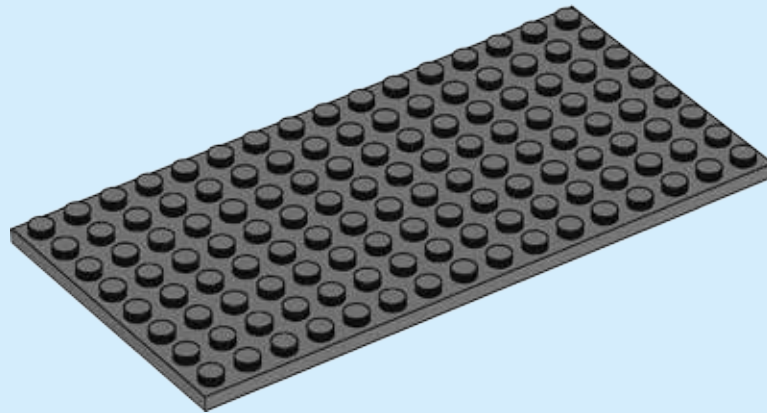



2x

2

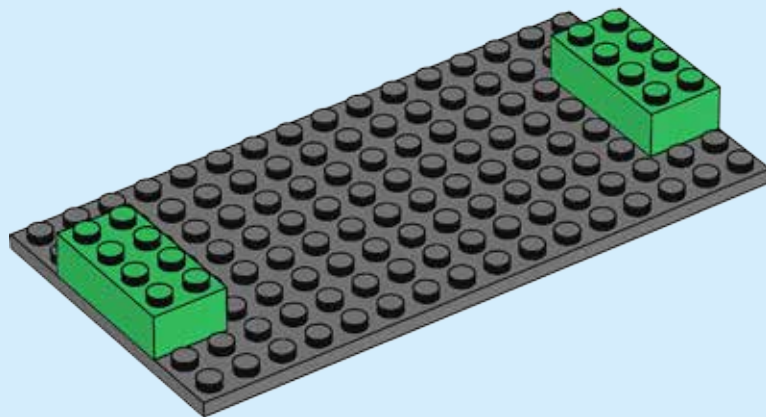

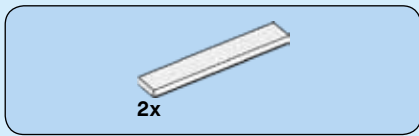

3

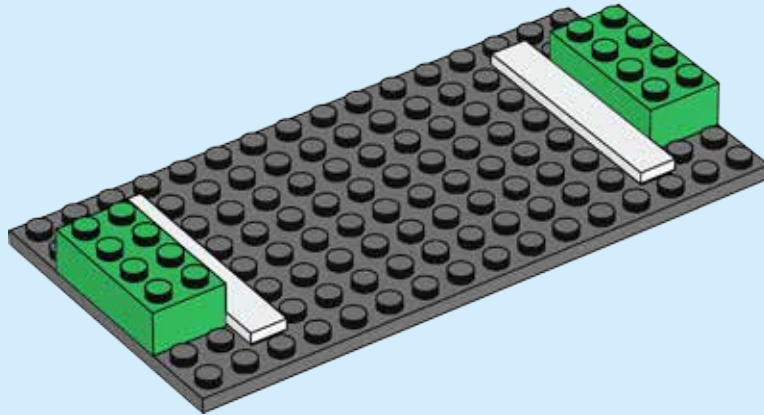



4x

4

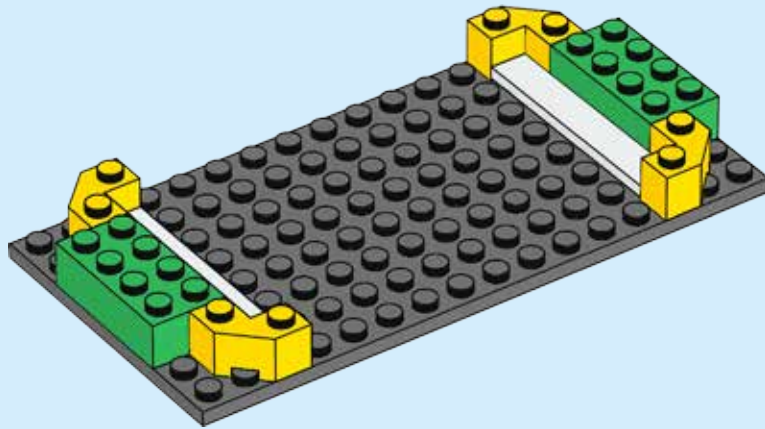

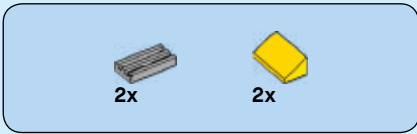

5

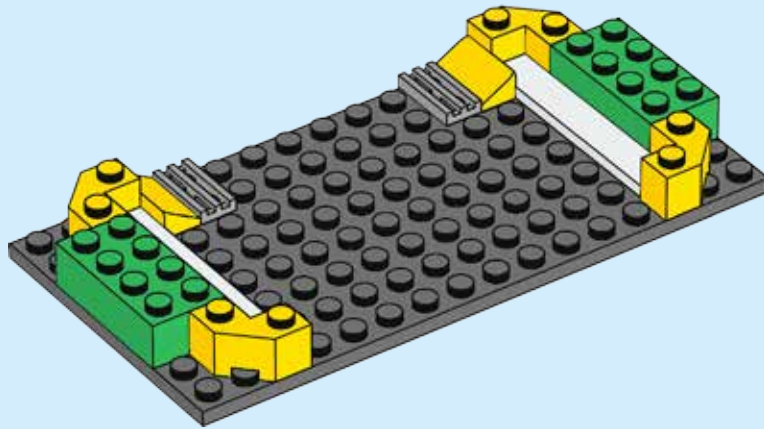

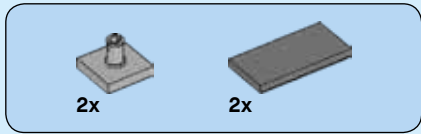

6

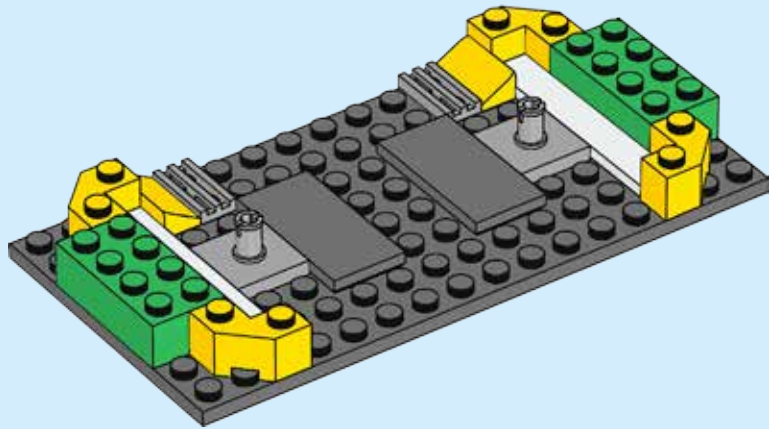

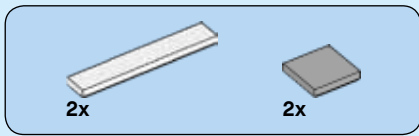

7

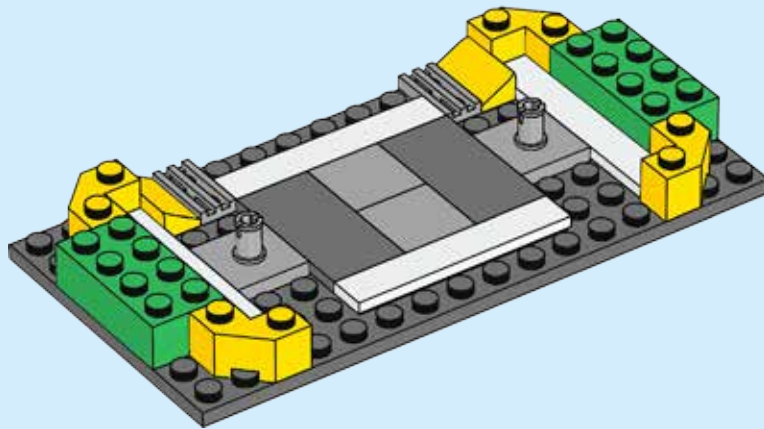



4x



2x

8

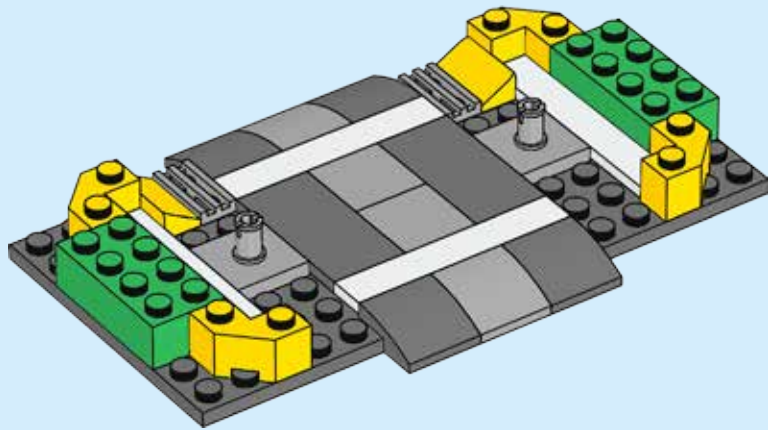

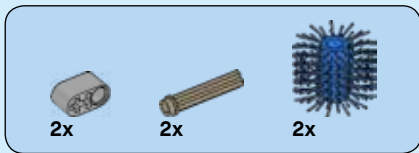

9

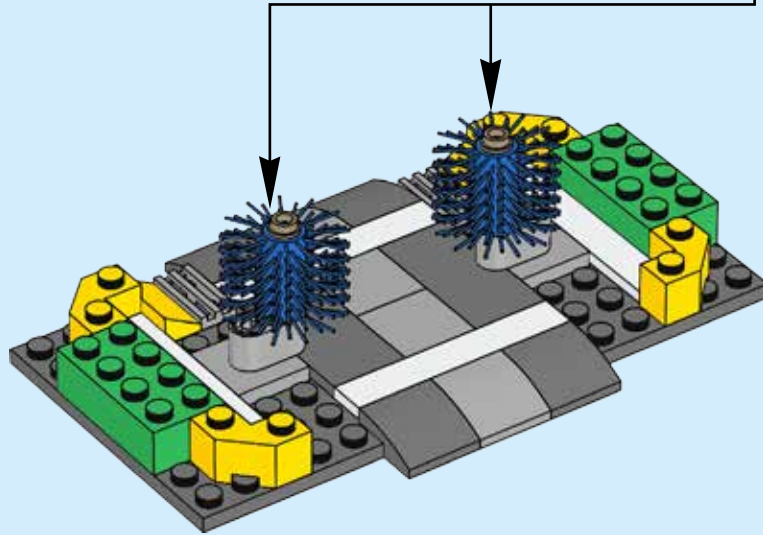
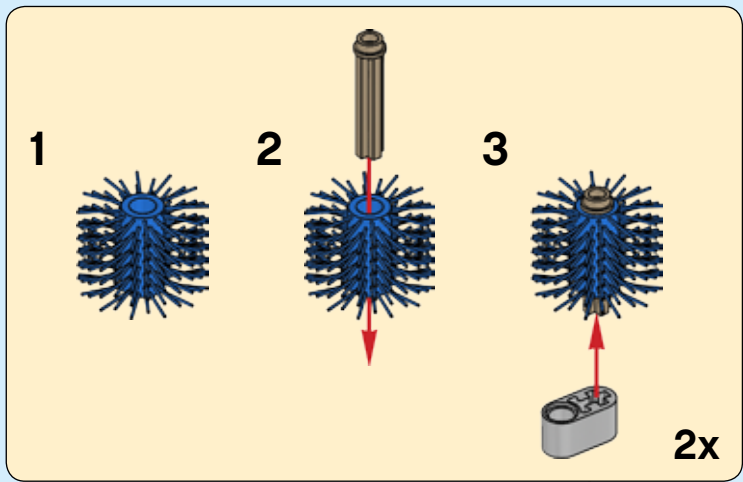



2x

10

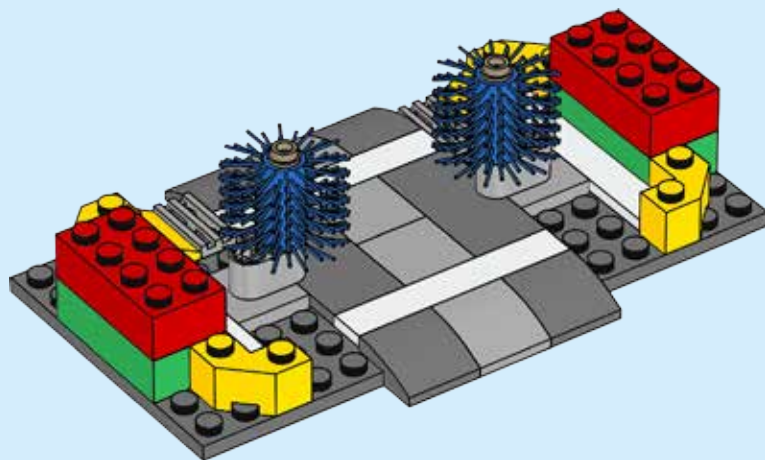



2x

11

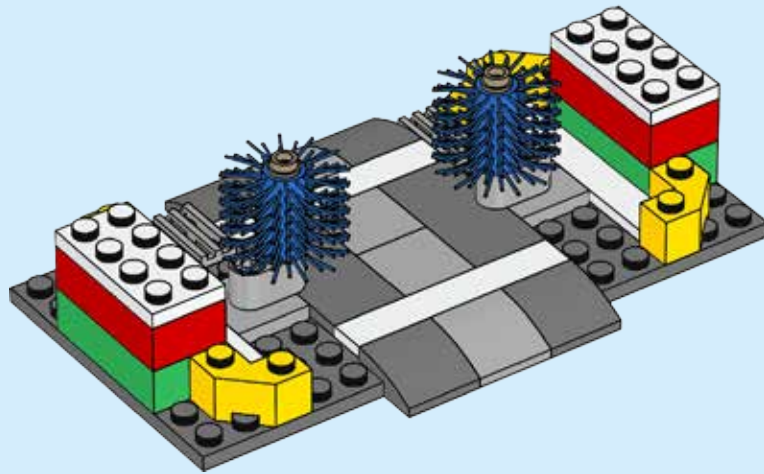



2x

12

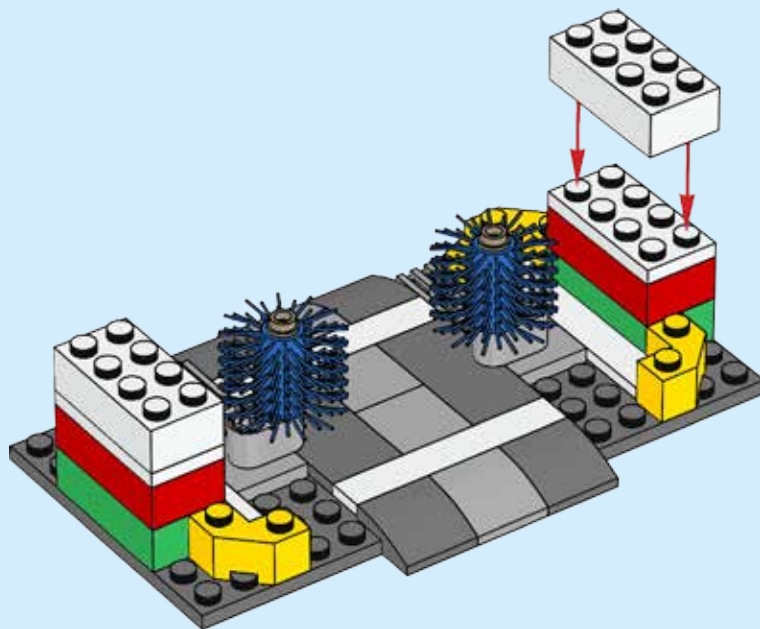



2x

13

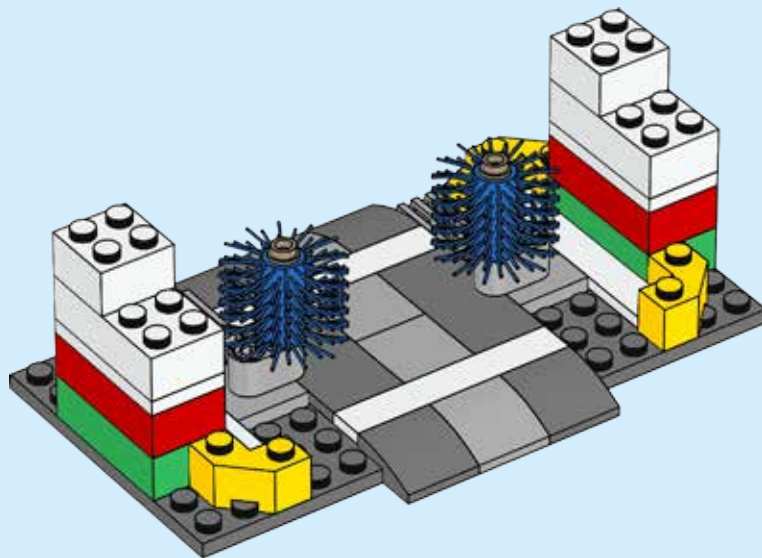



14

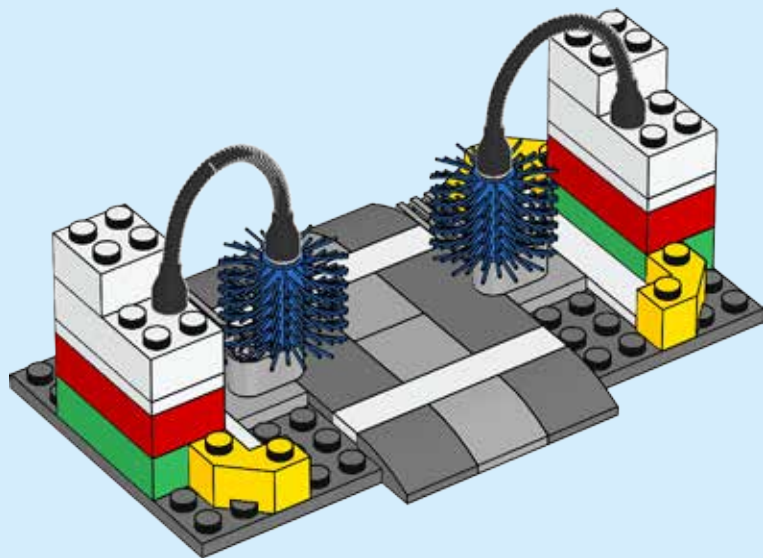

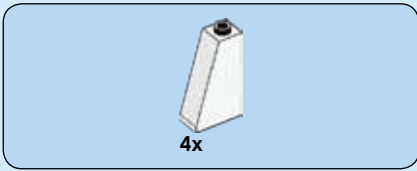

15

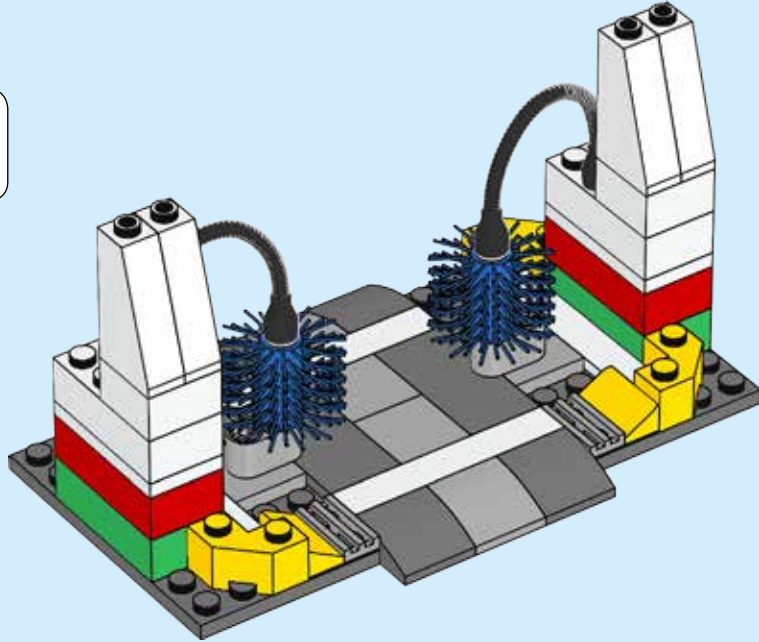
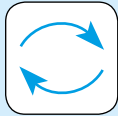

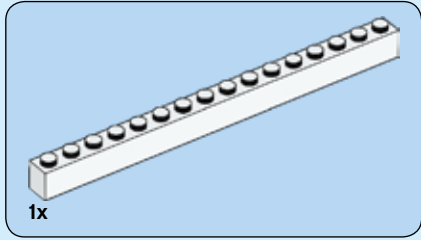
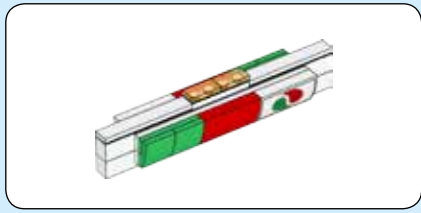

16

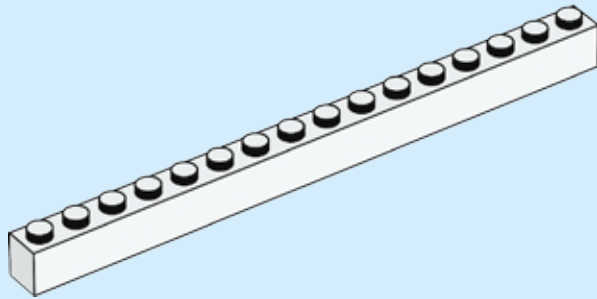

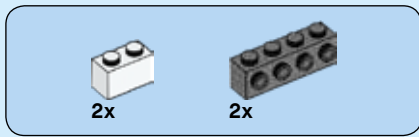

17

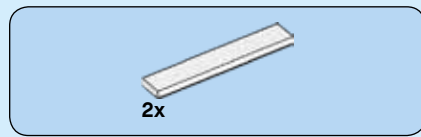
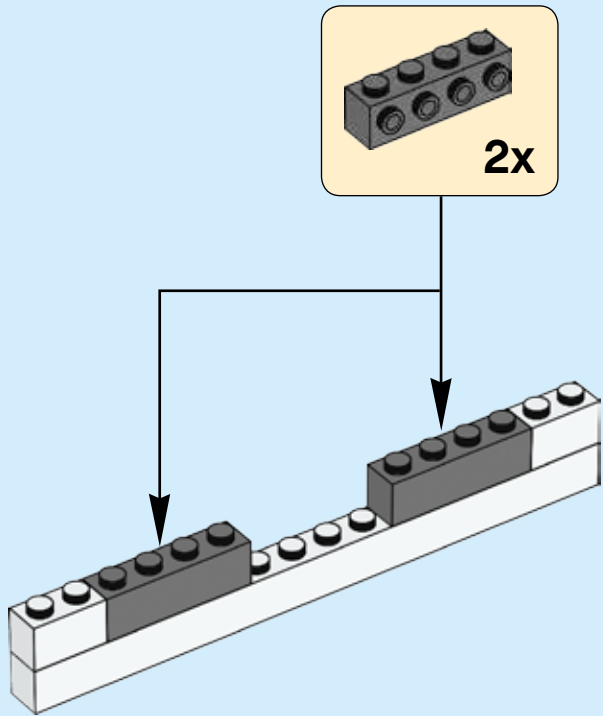

18

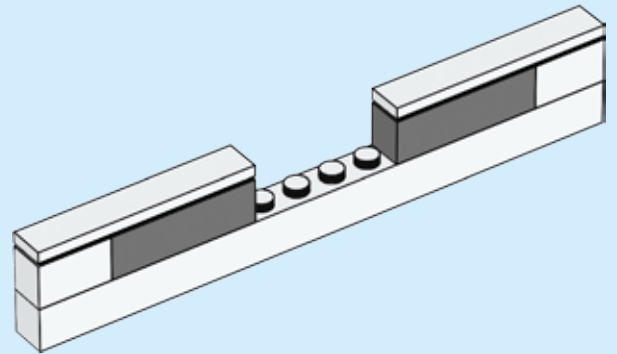

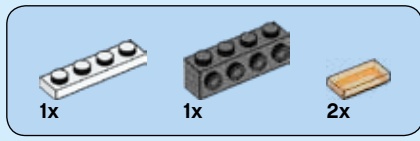

19

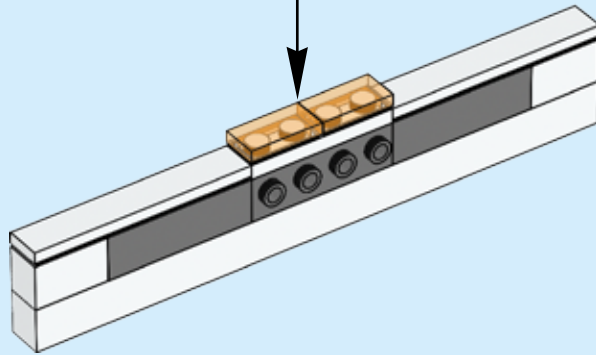
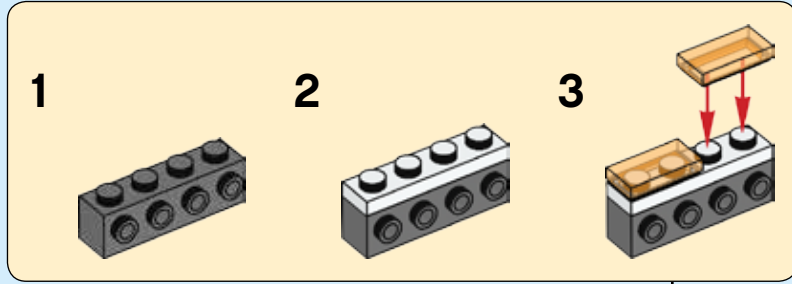

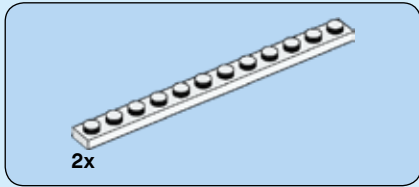
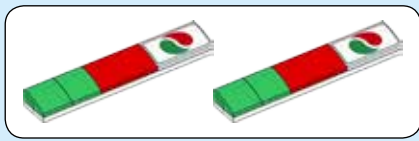

20

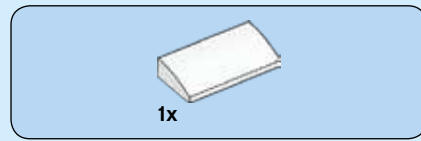
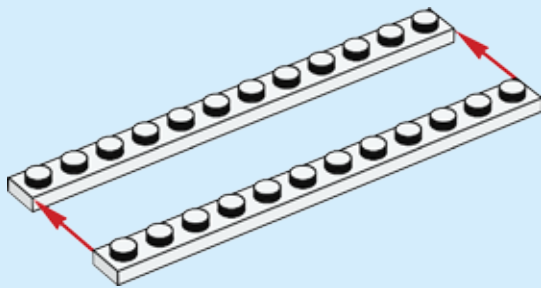

21

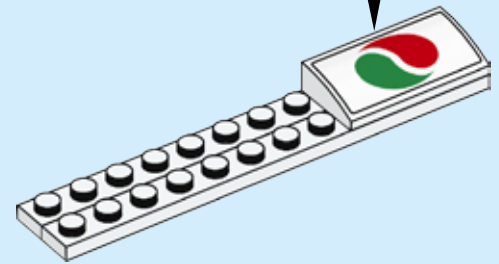
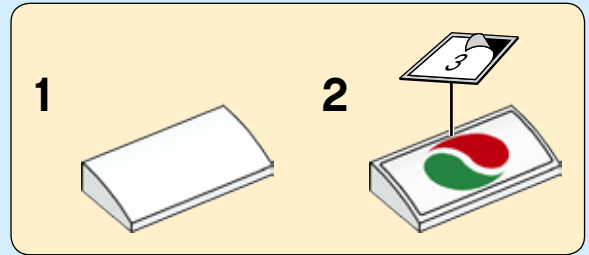

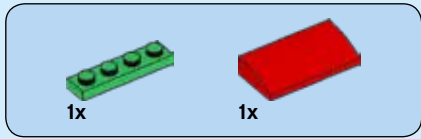

22

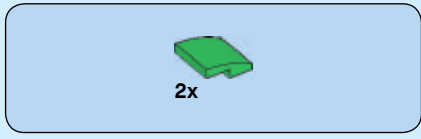
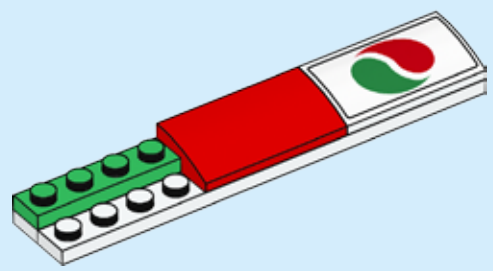

23

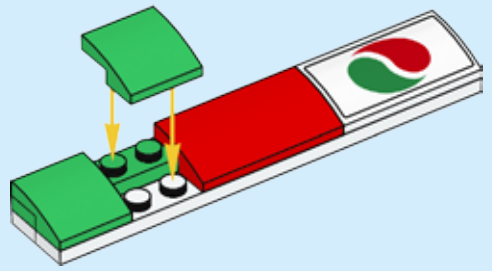

2x

24

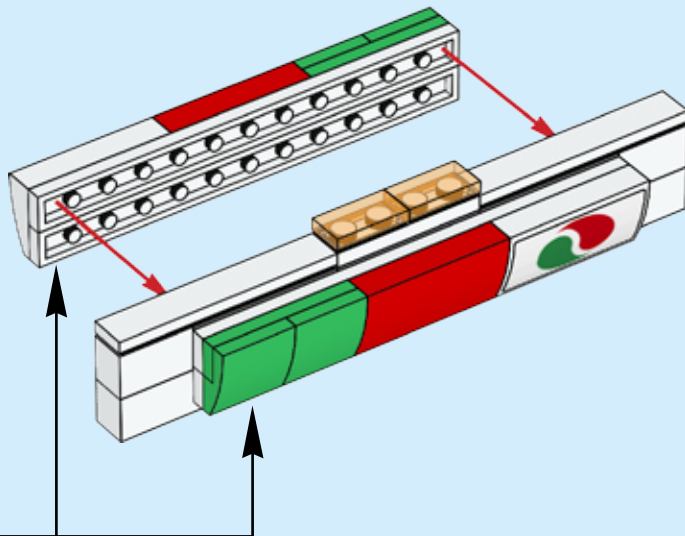

25

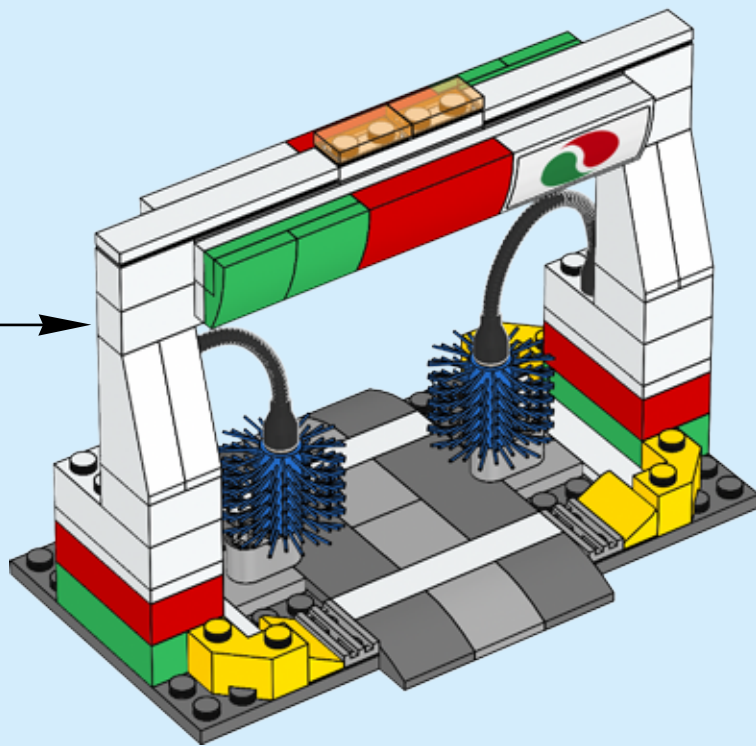
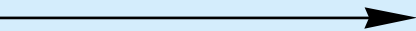



2x

1

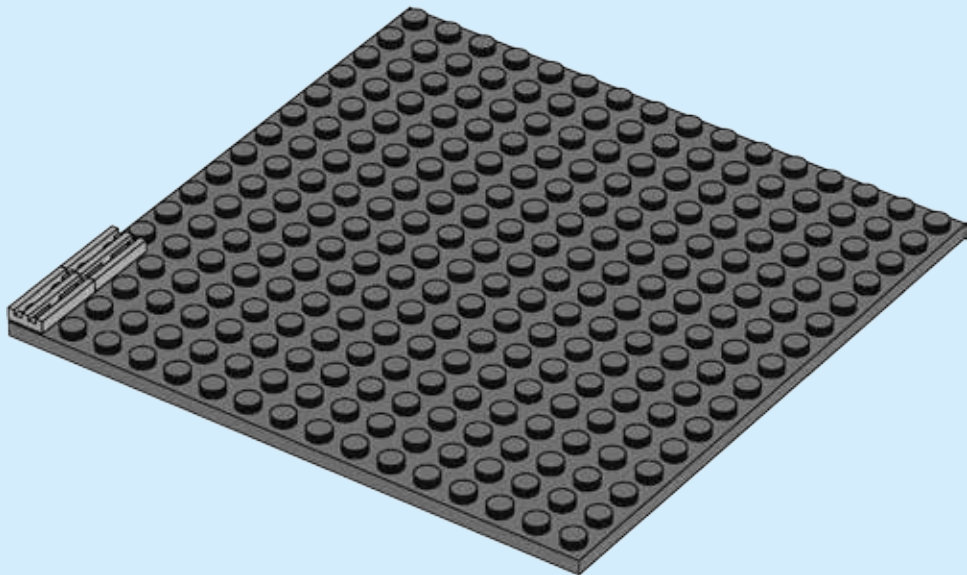

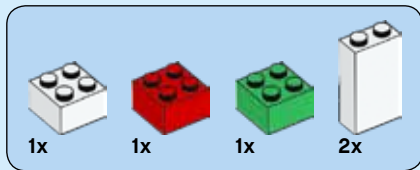

2

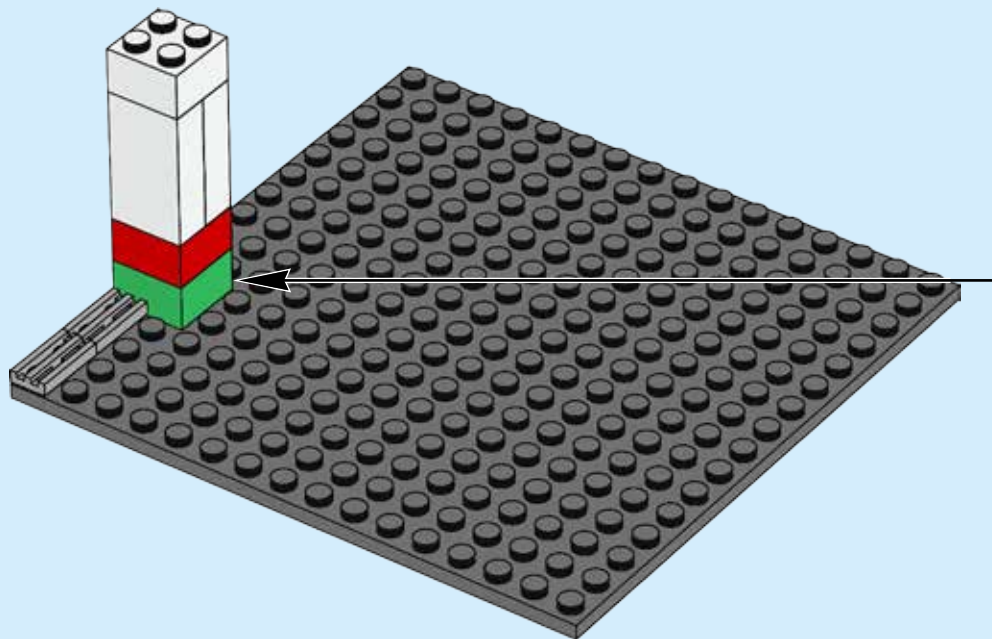
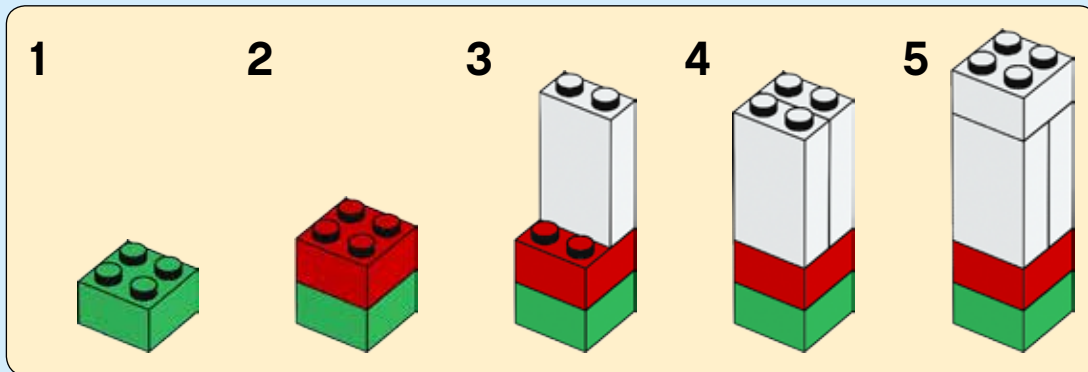

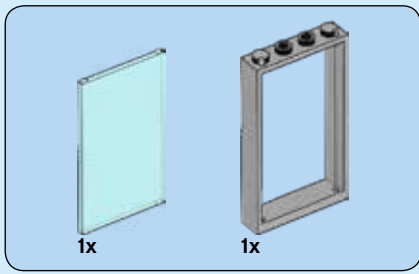

3

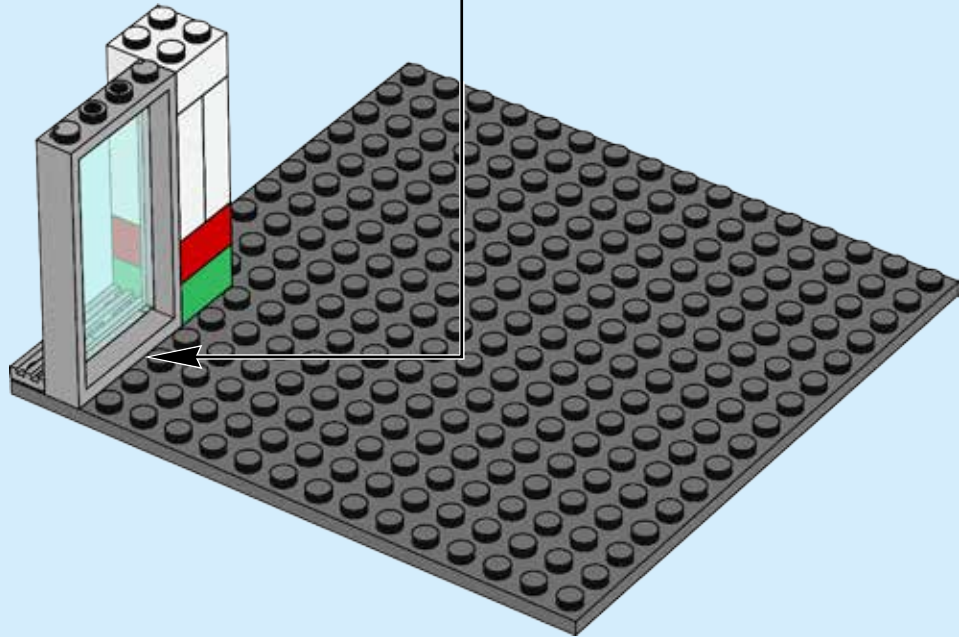
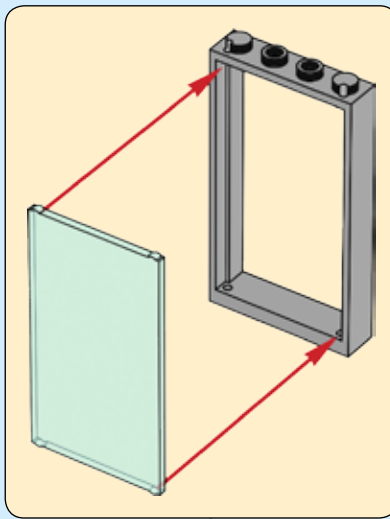

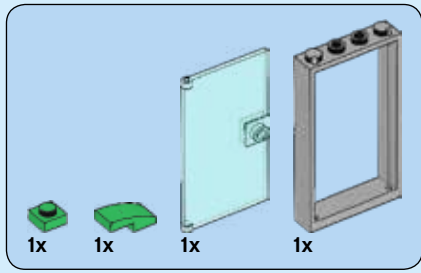

4

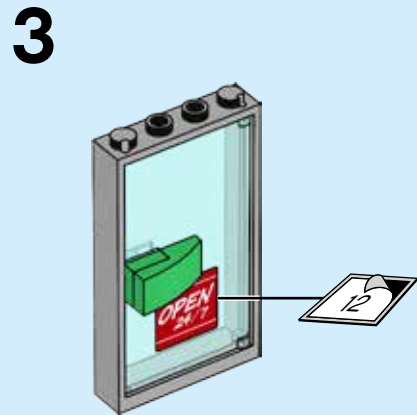
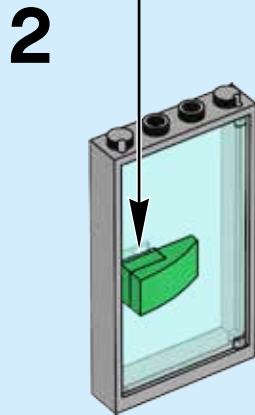
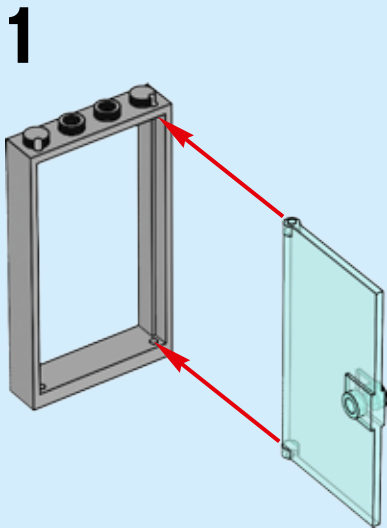

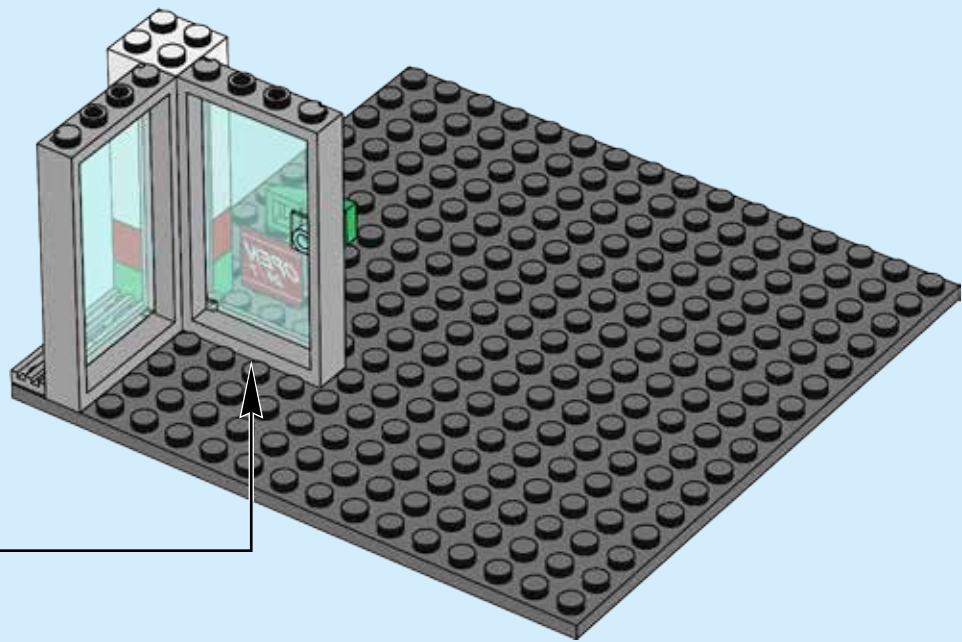



2x

5

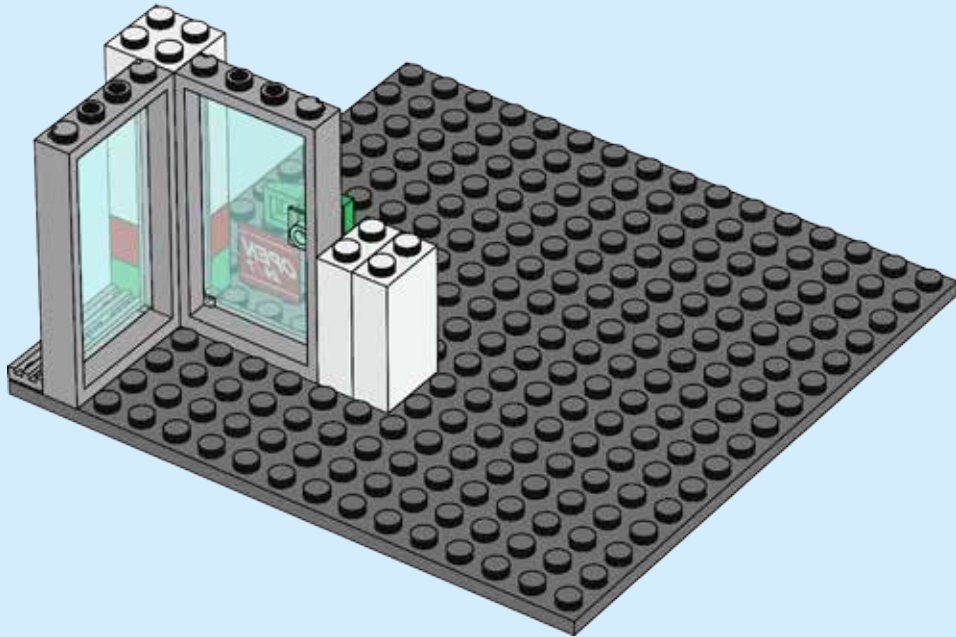

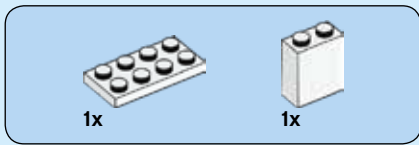

6

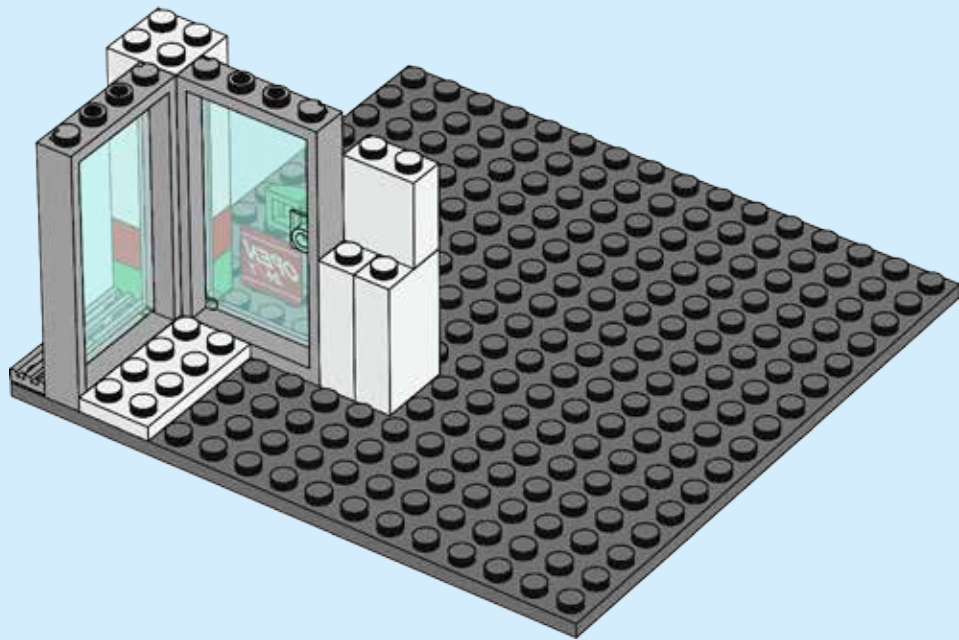



7

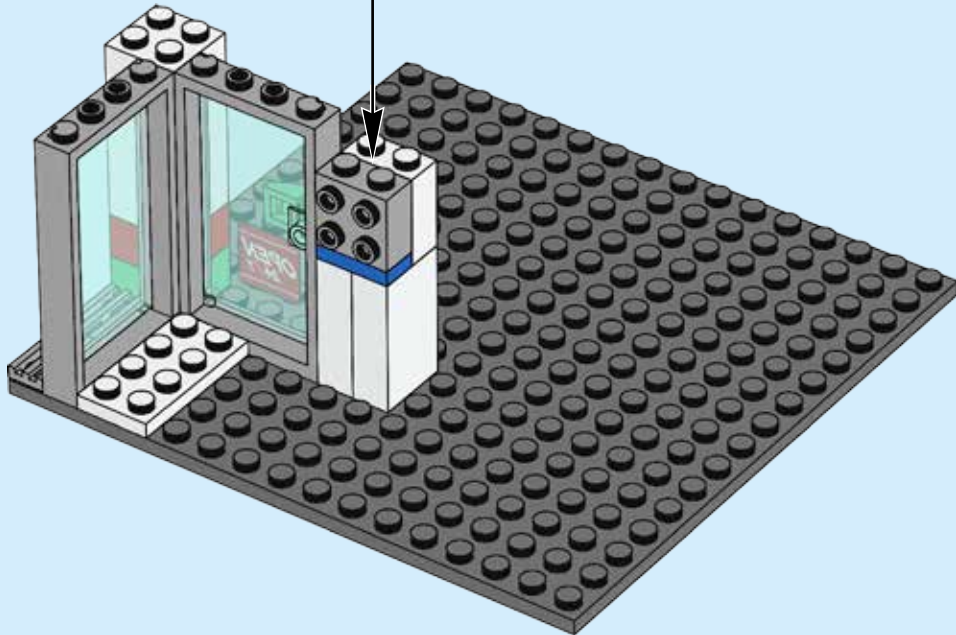
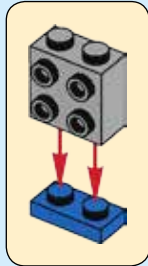



8

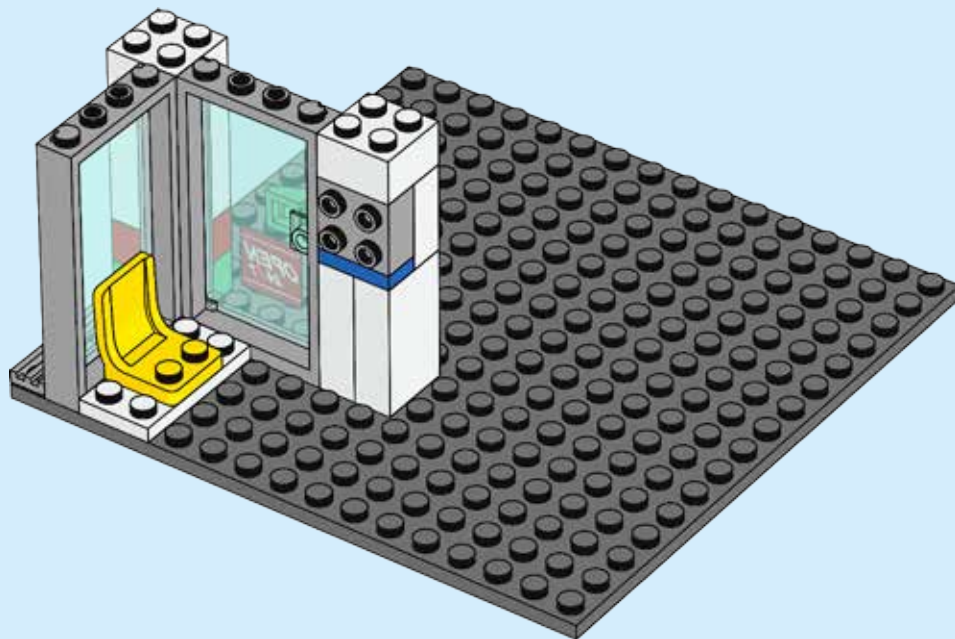

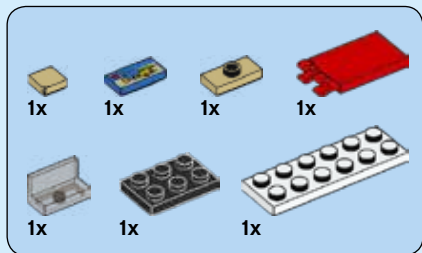

9

1



2

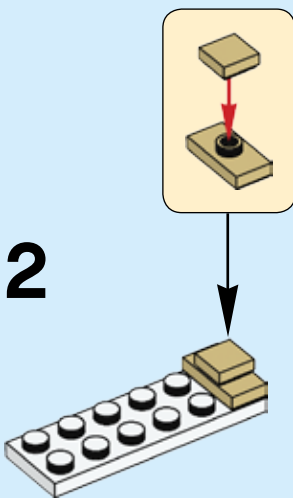

3

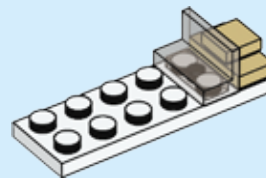

4

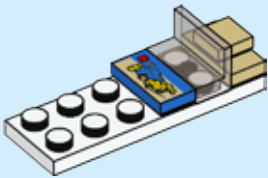

5

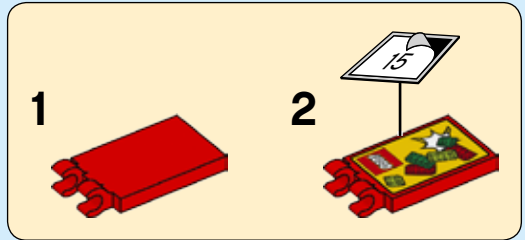
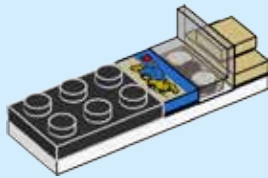

6

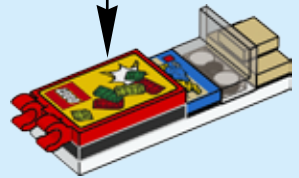

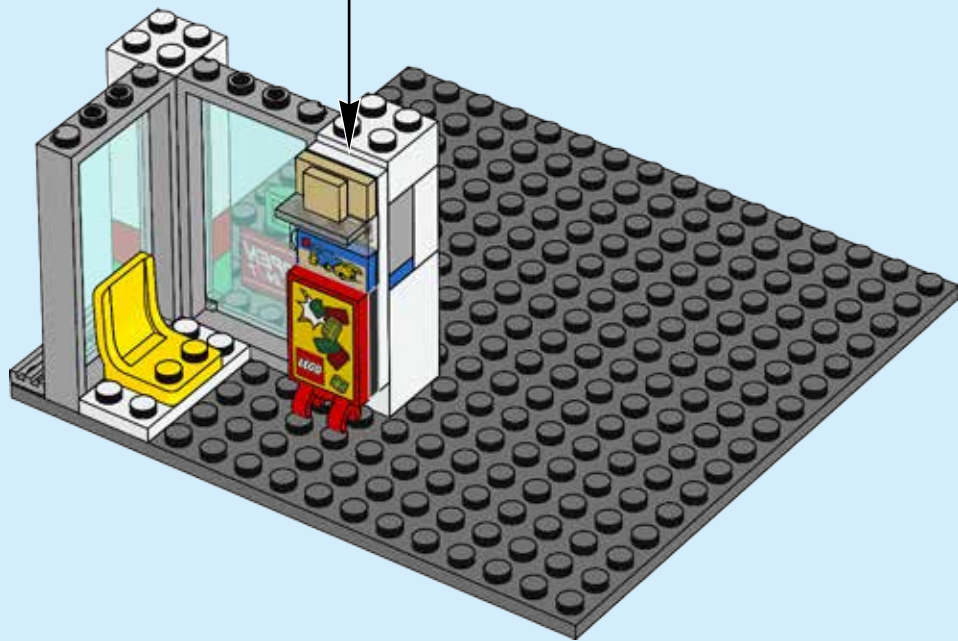

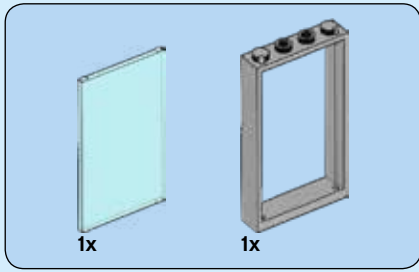

10

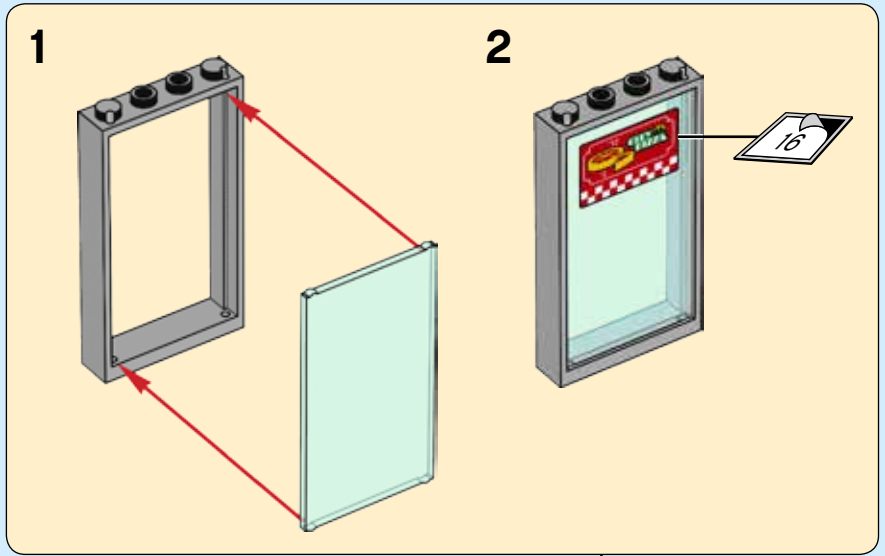



1x

11



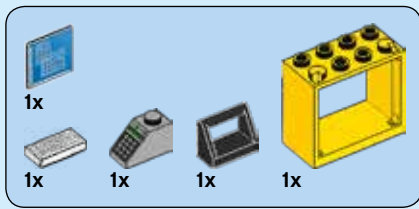

12

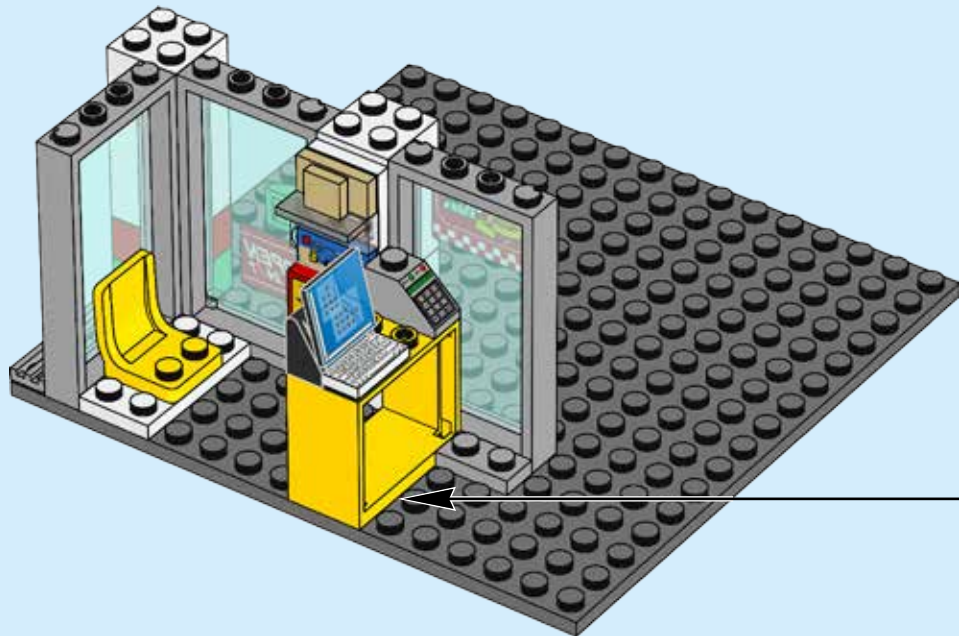
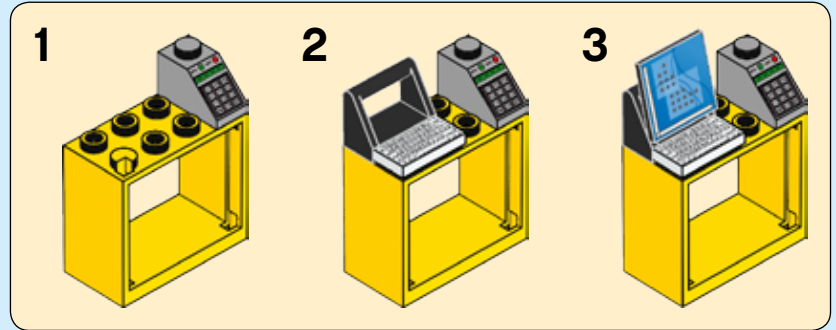

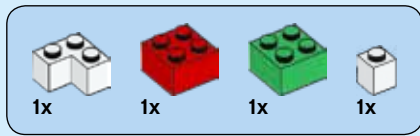

13

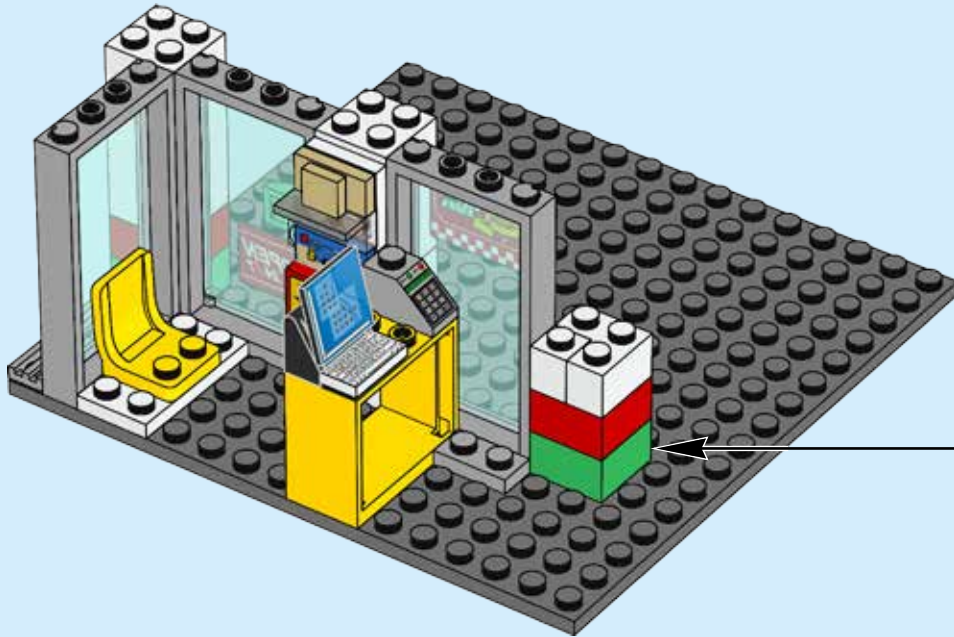
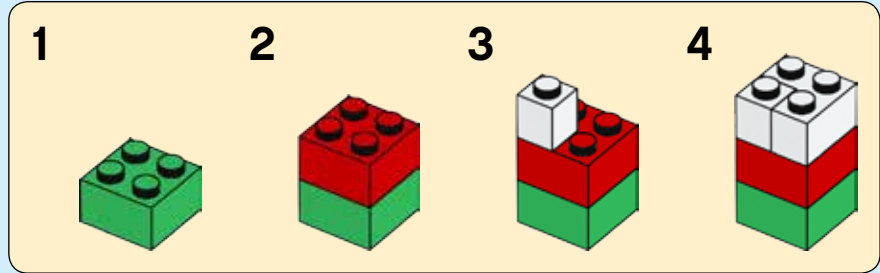



1x



2x

14

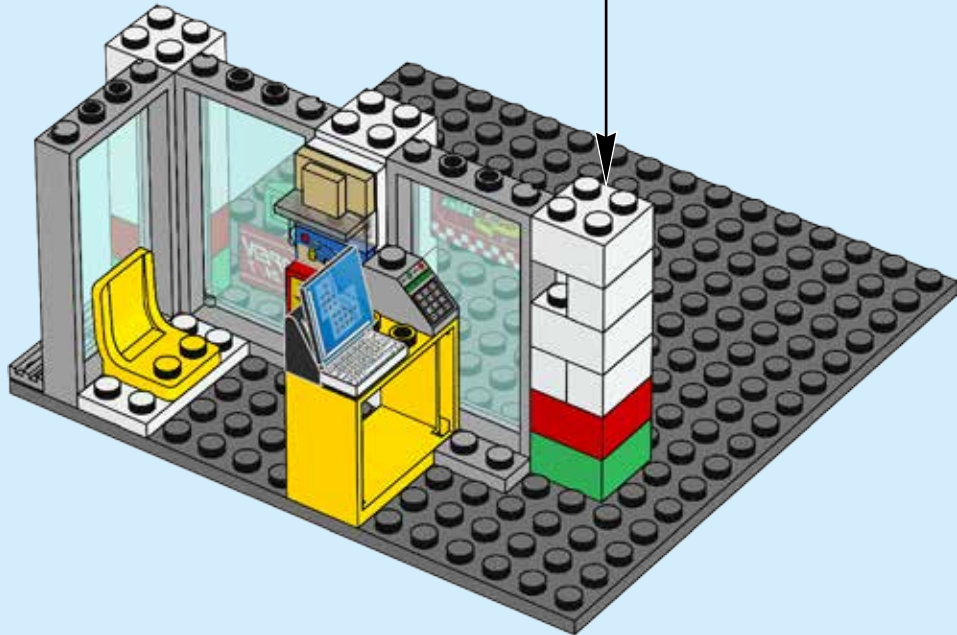
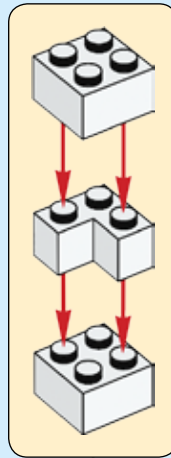

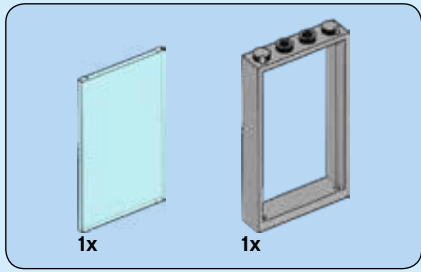

15

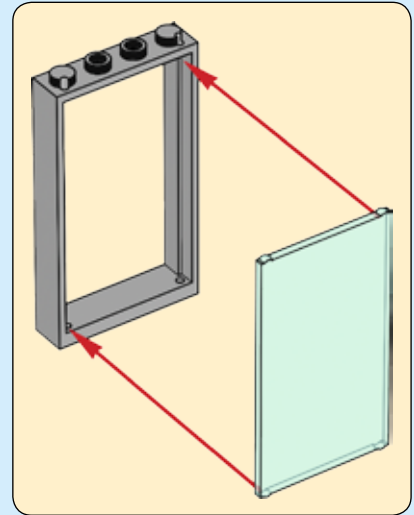

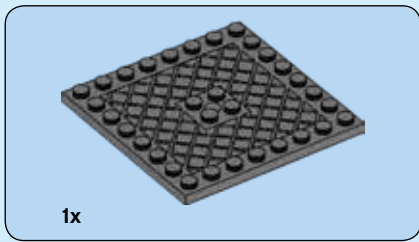

16

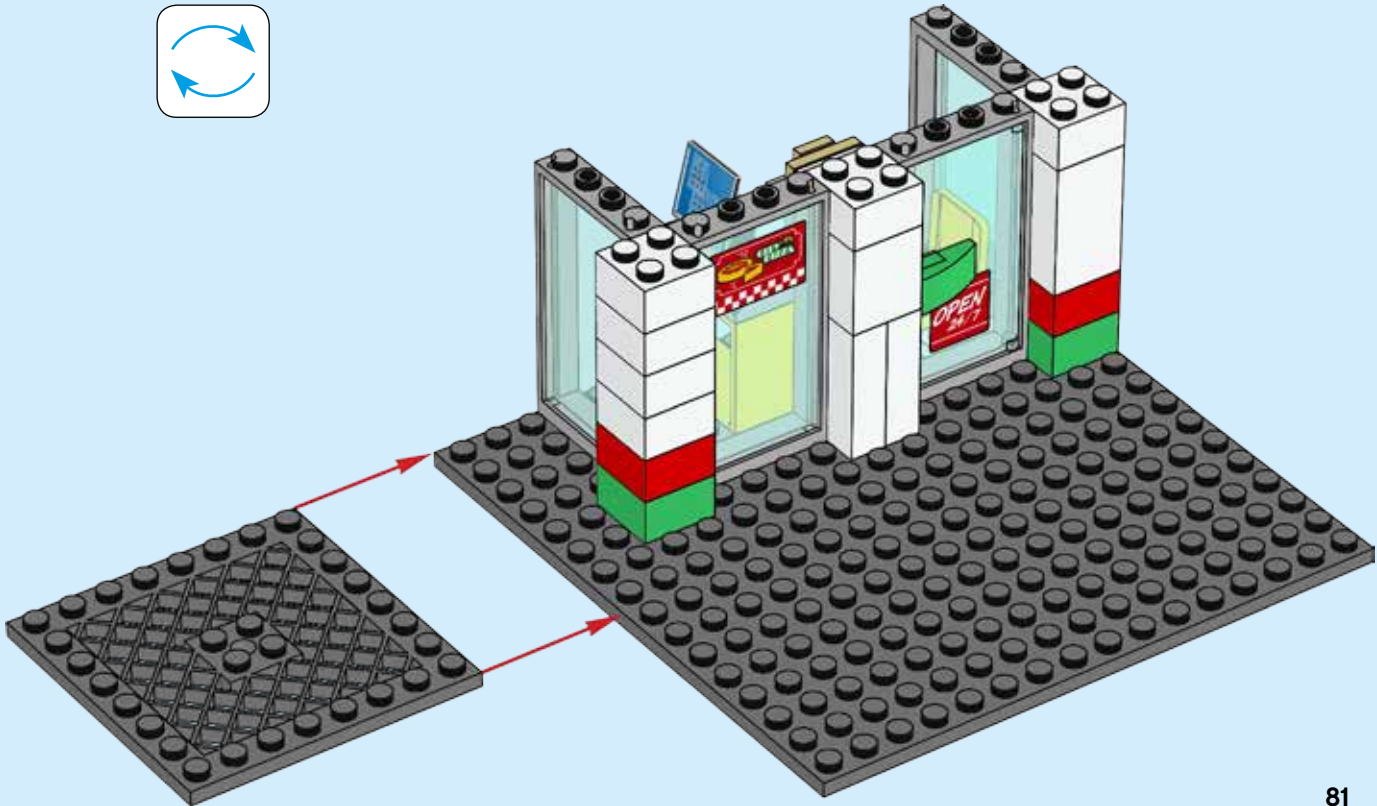
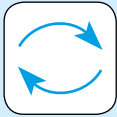

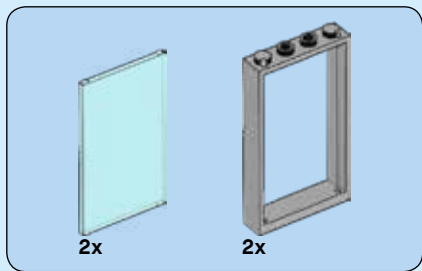

17

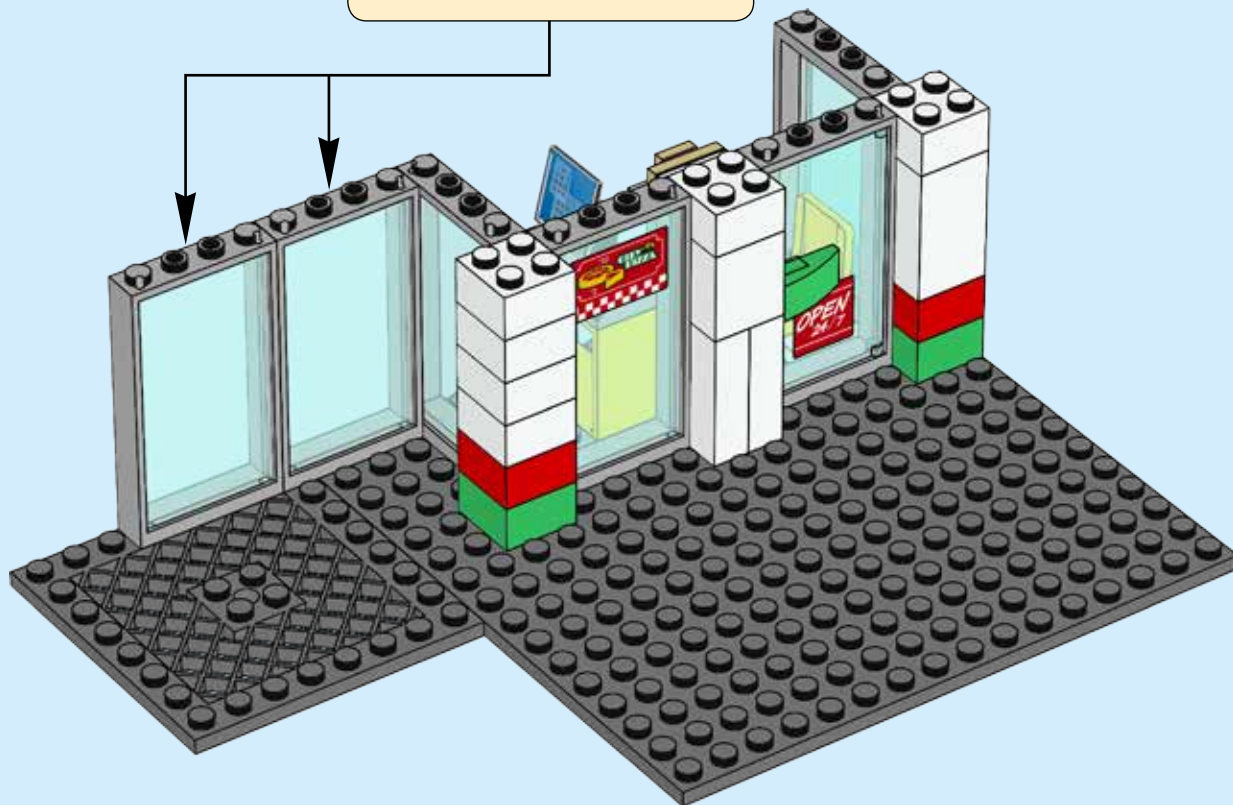
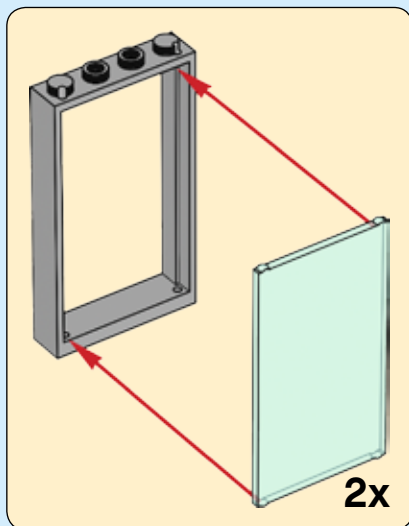



2x

18

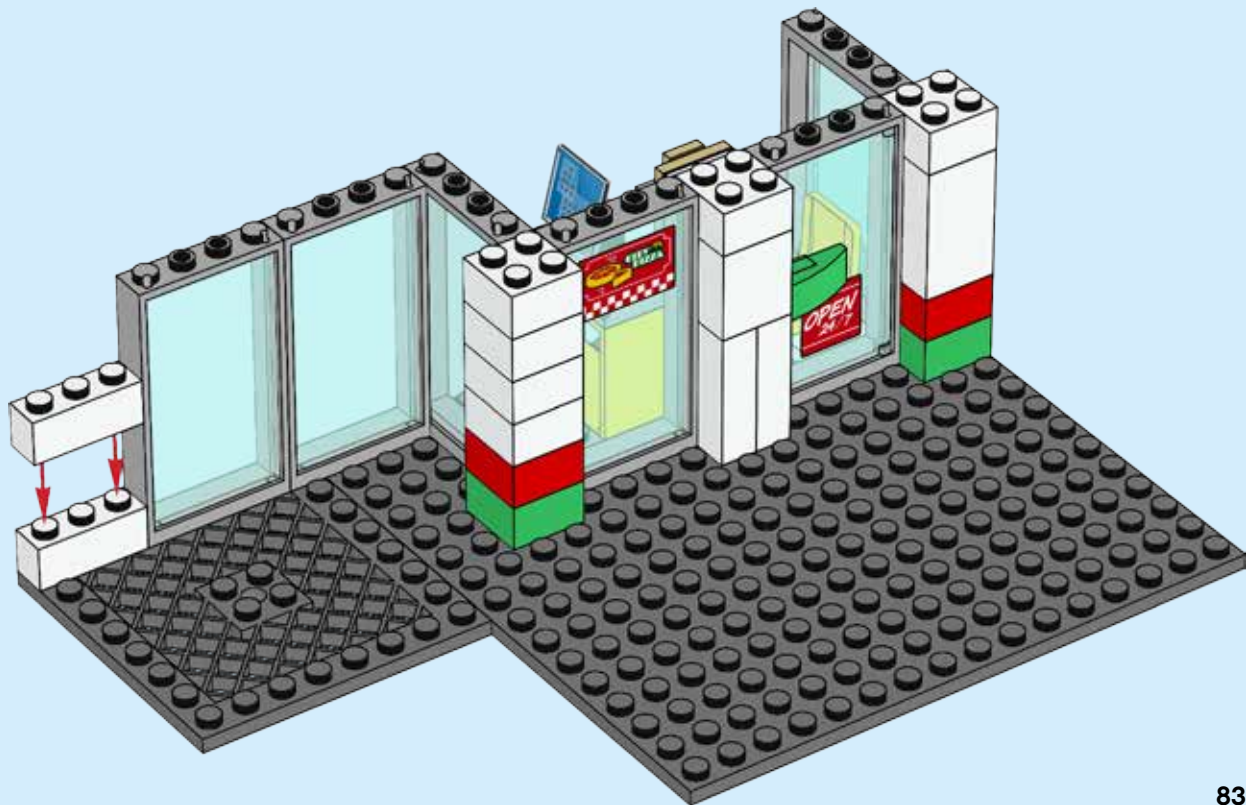

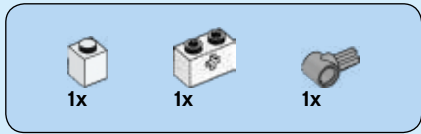

19

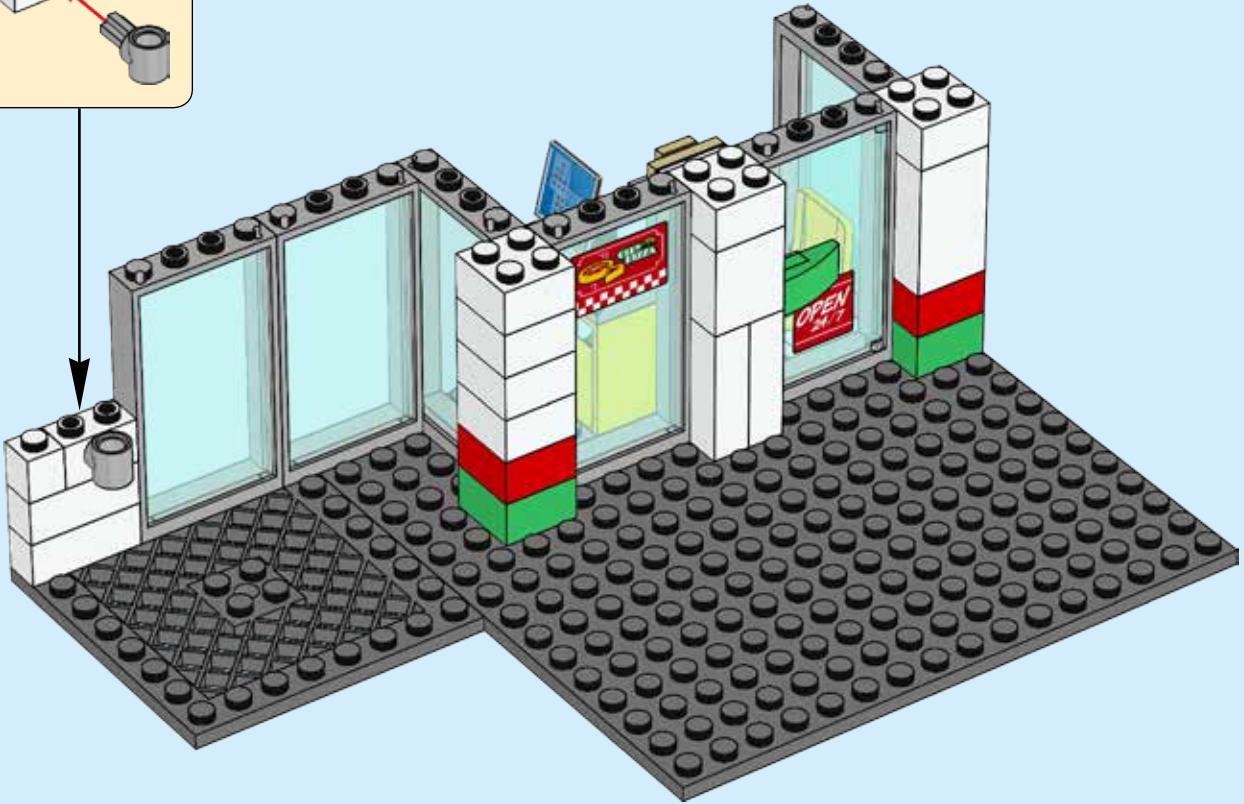
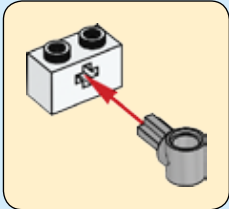



1x



1x



1x

20

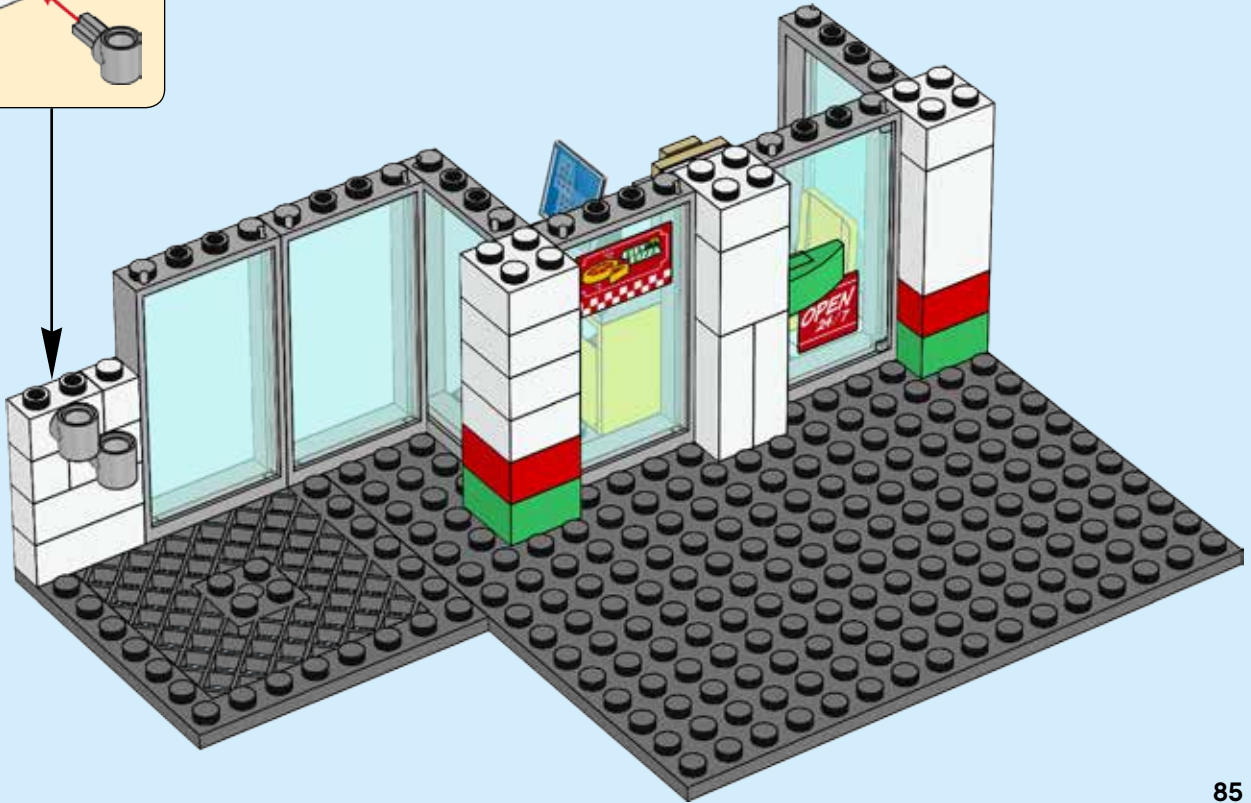
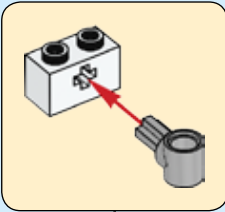



2x

21

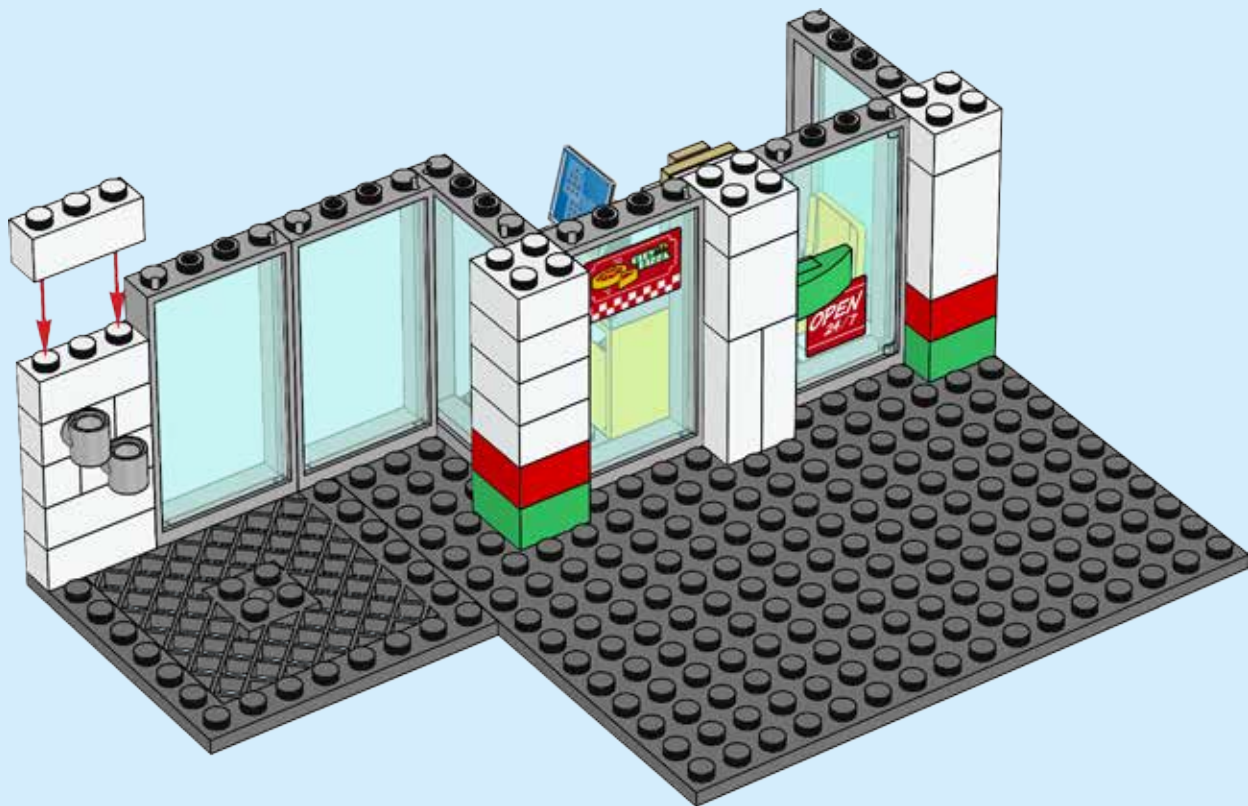

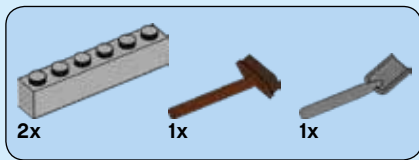

22

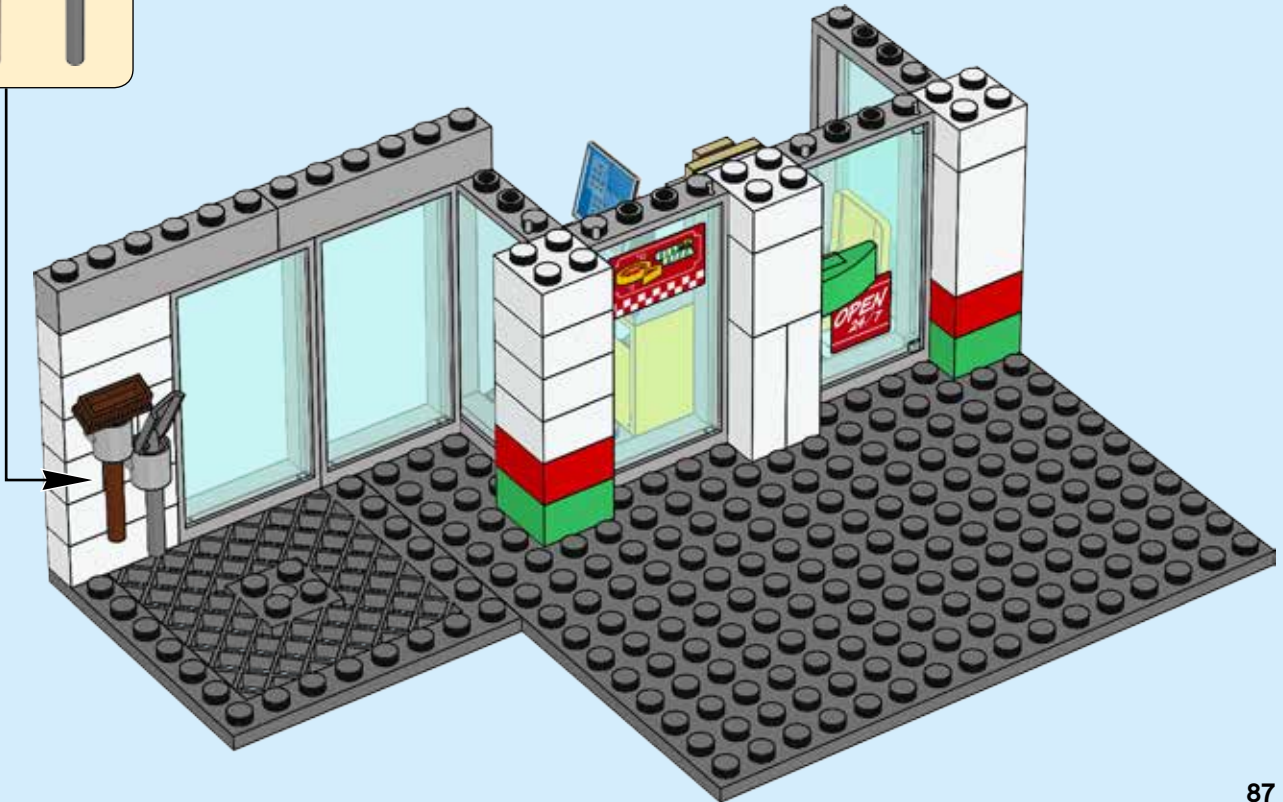

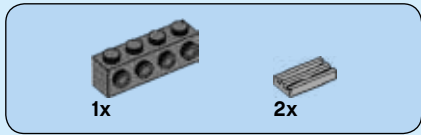

23

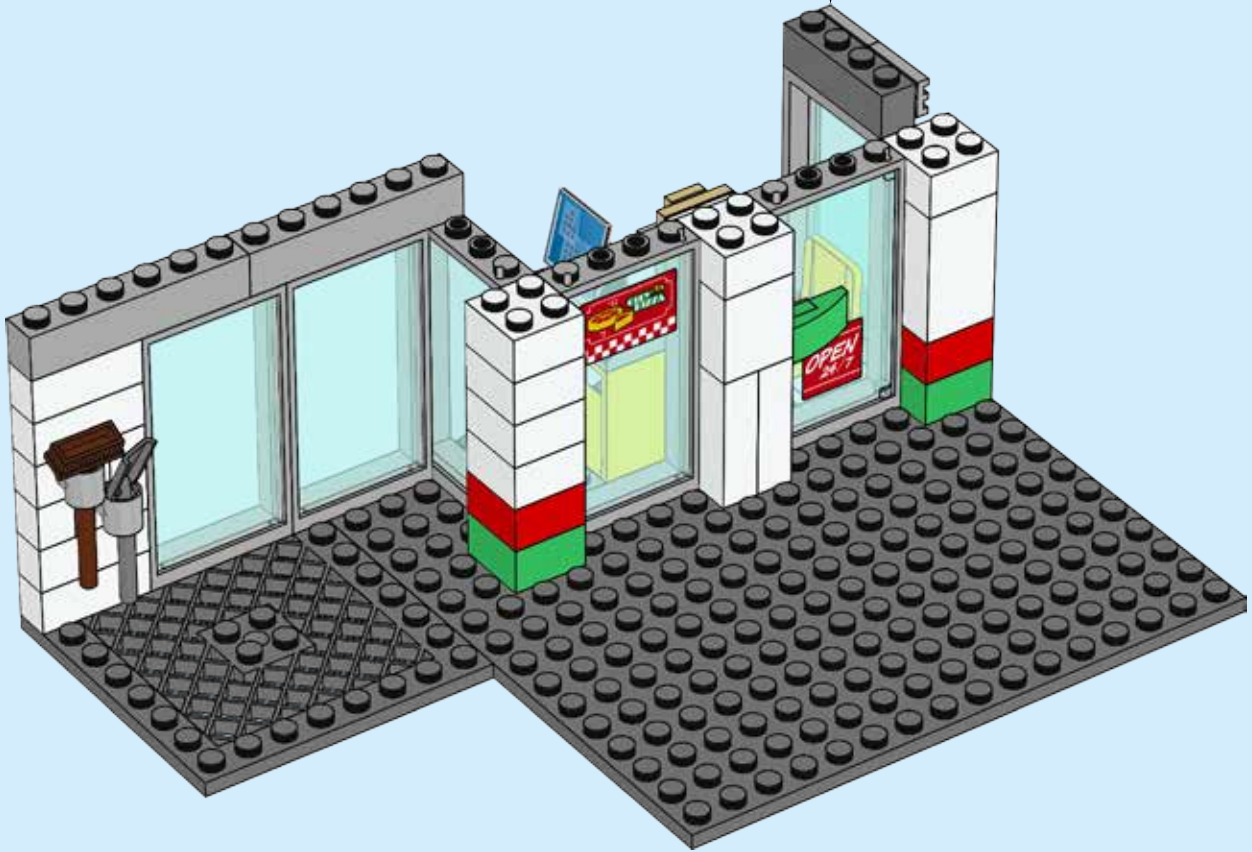
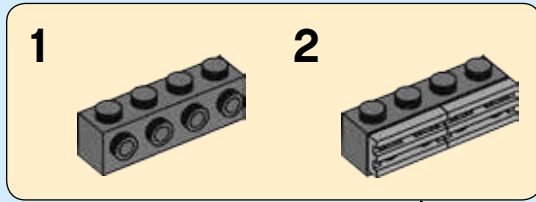

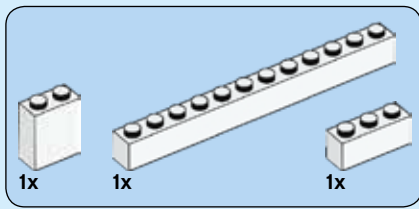

24

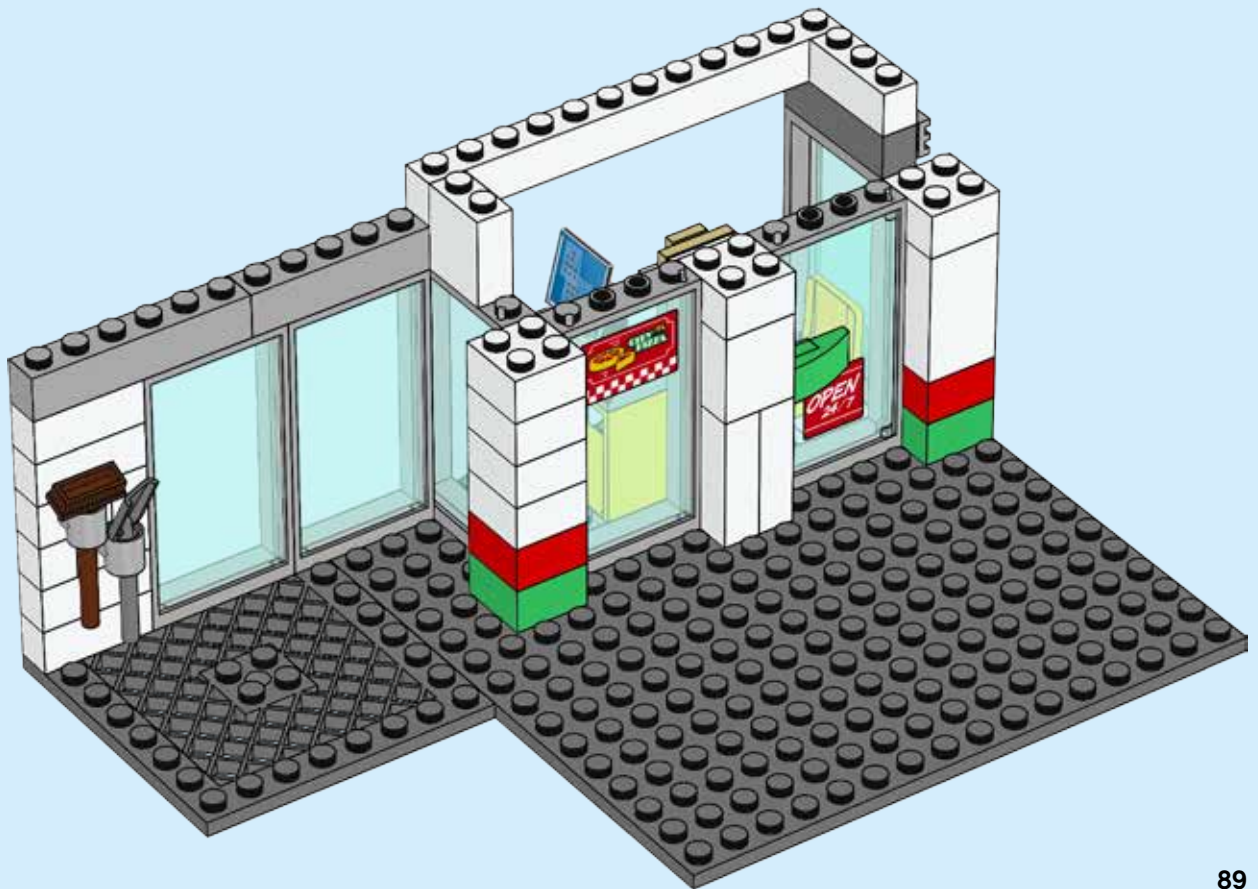



2x

25

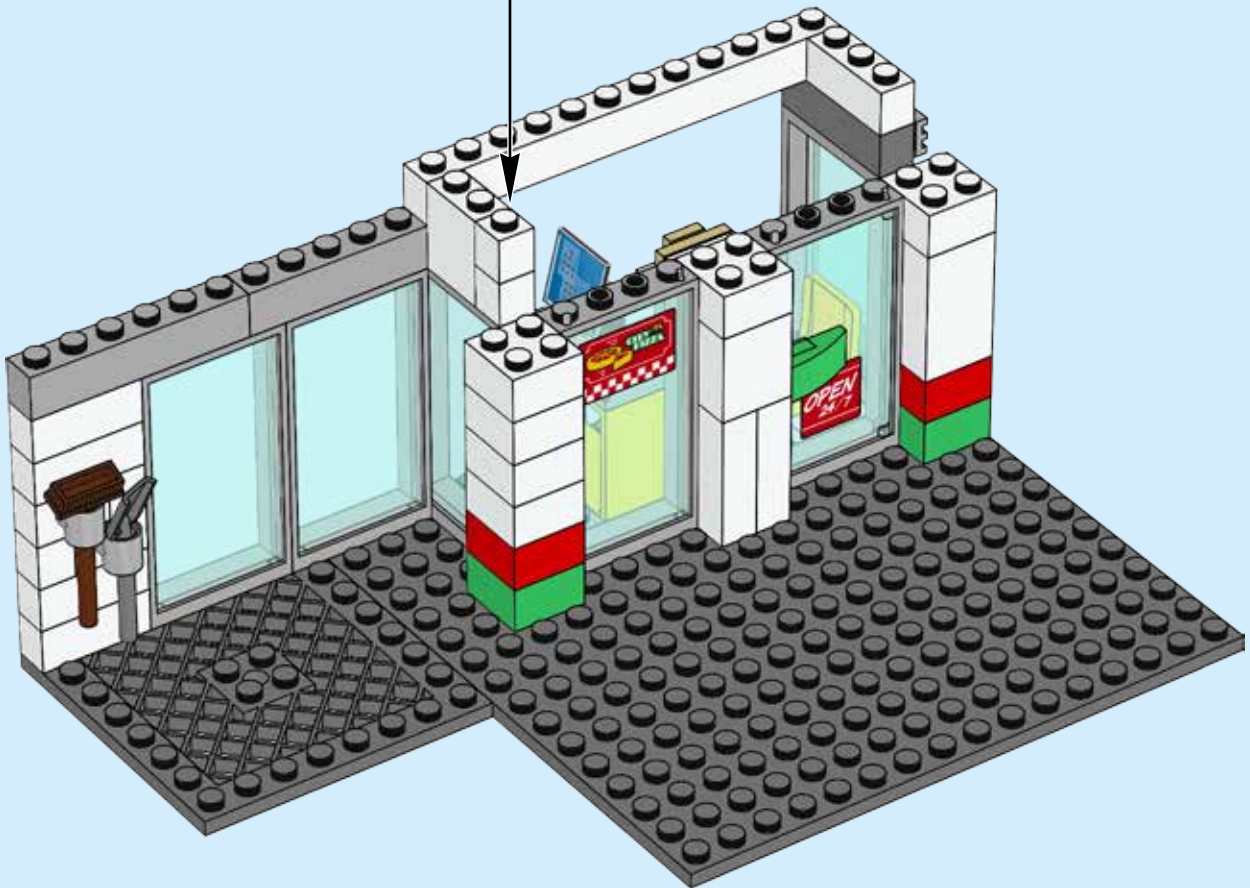
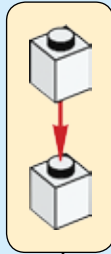

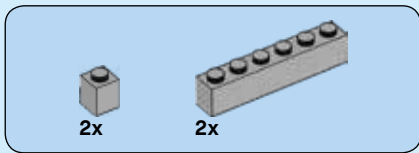

26

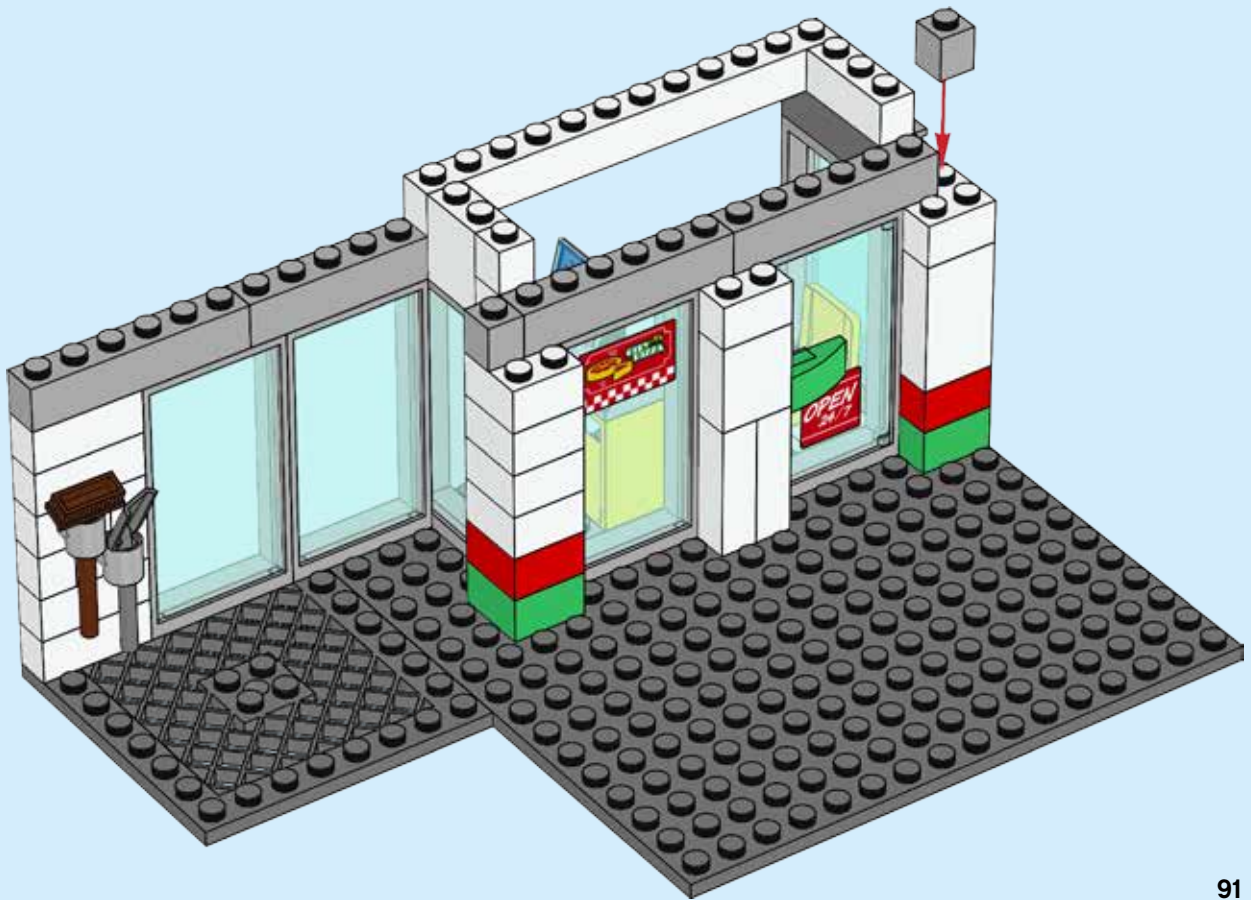



3x

27

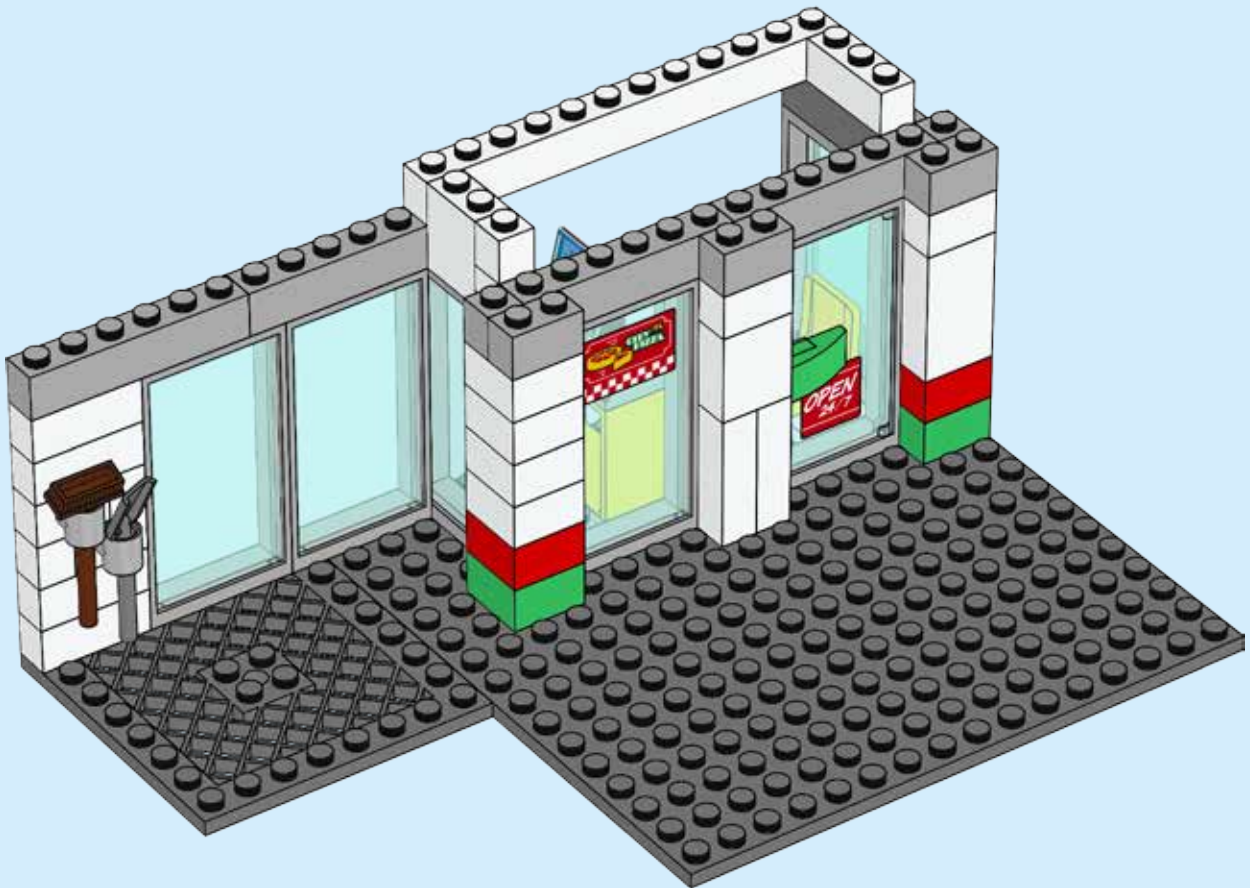

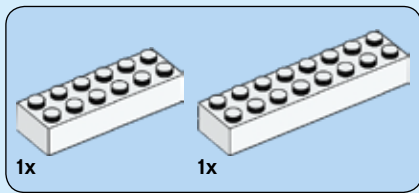

28

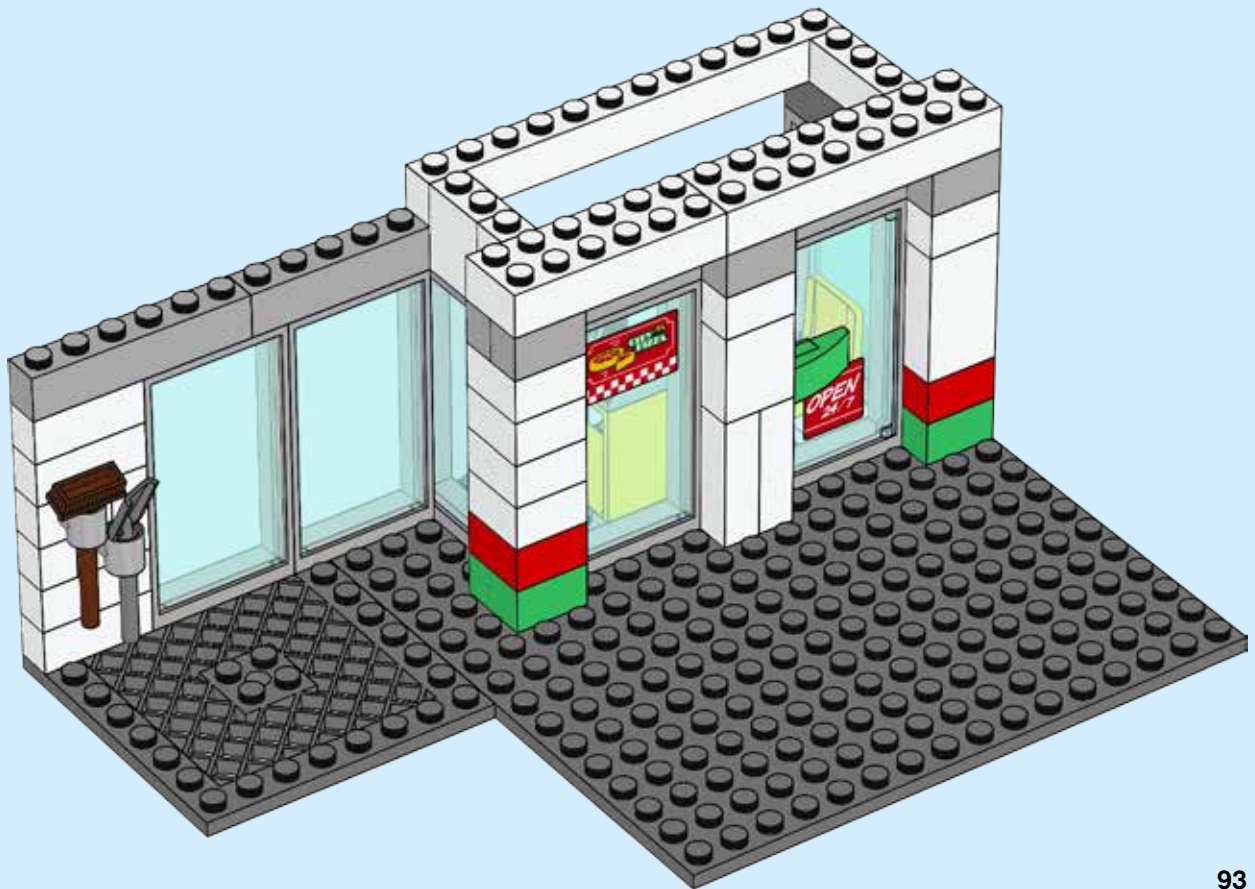

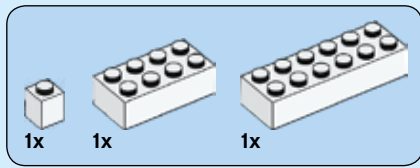

29

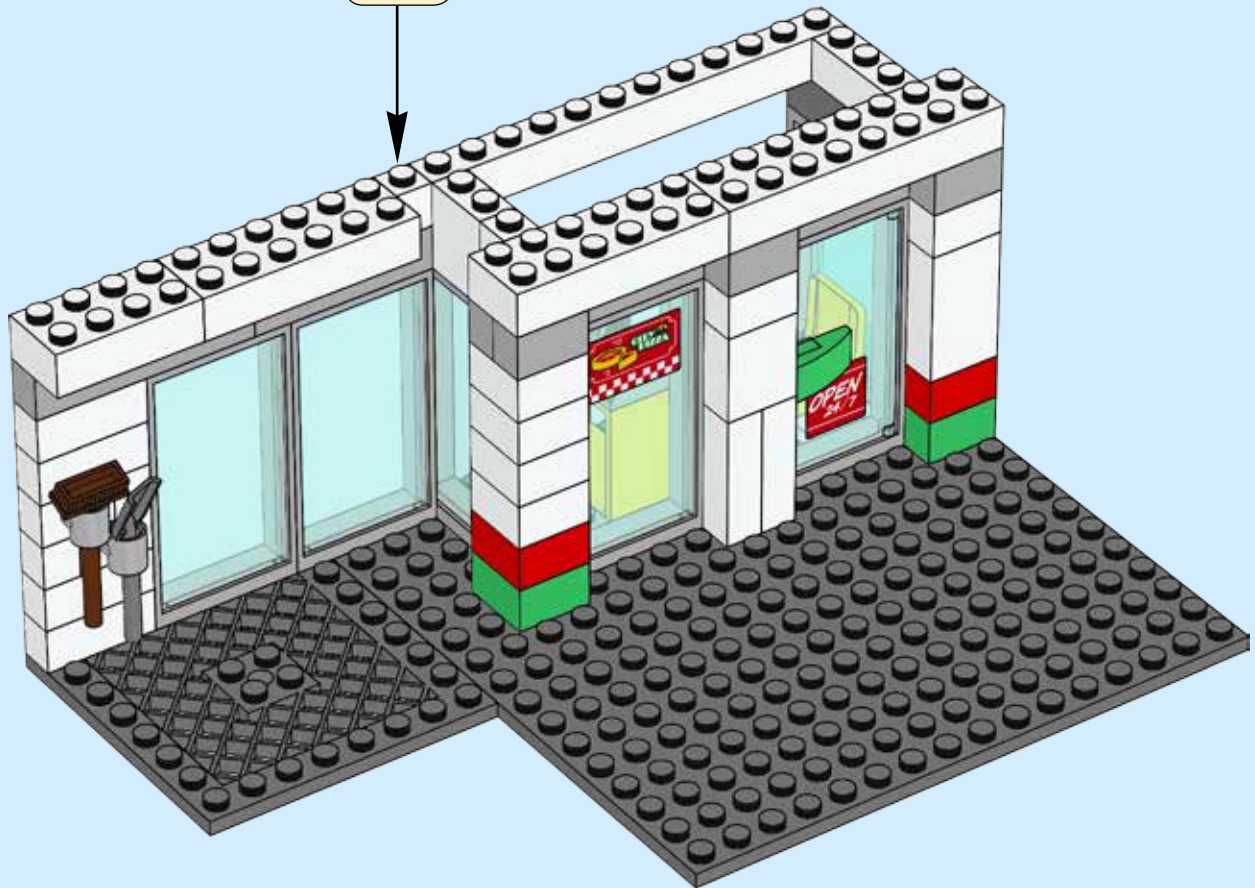

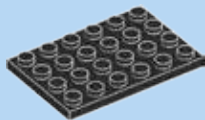

4x

30

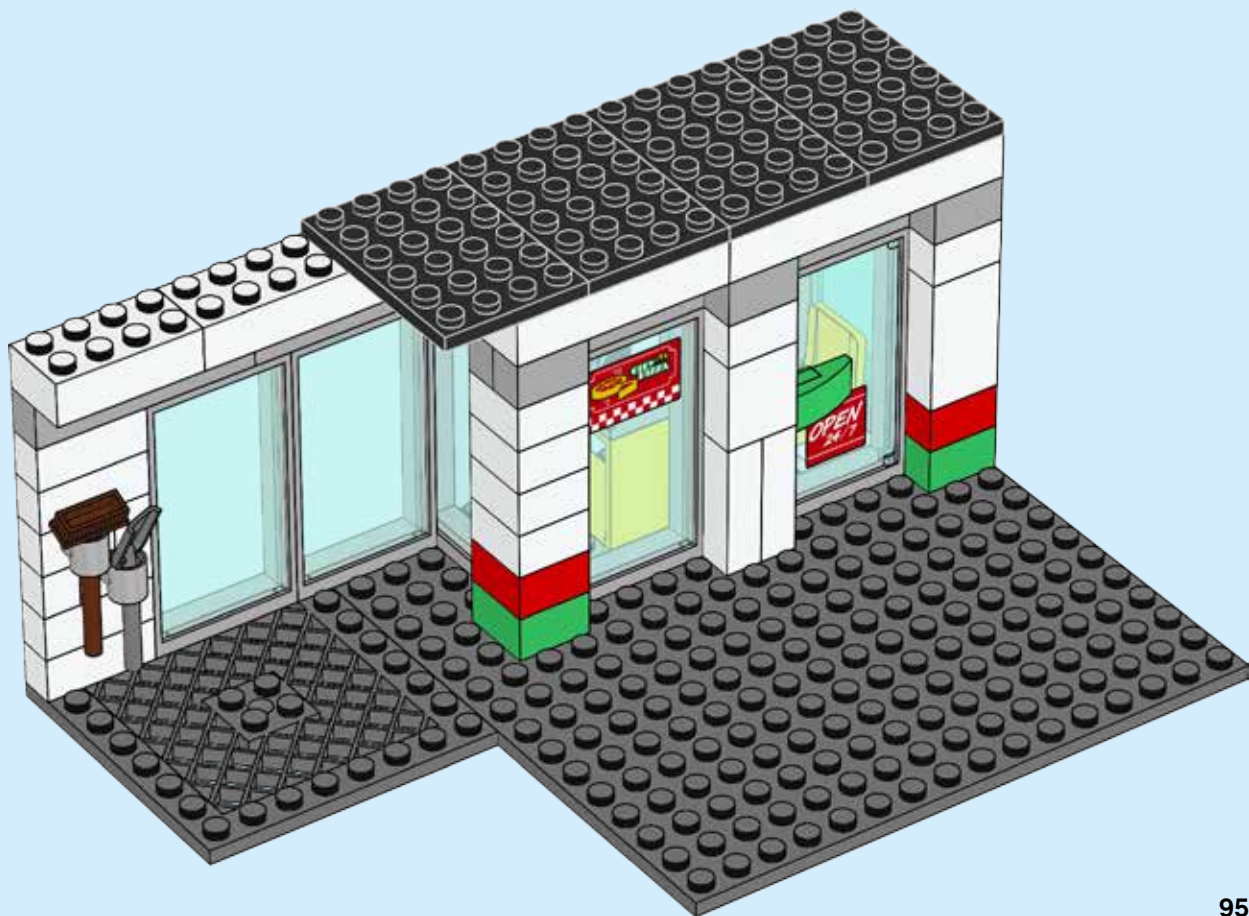

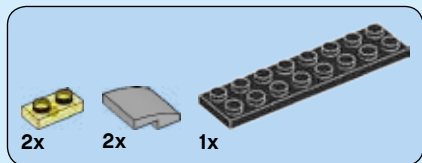

31

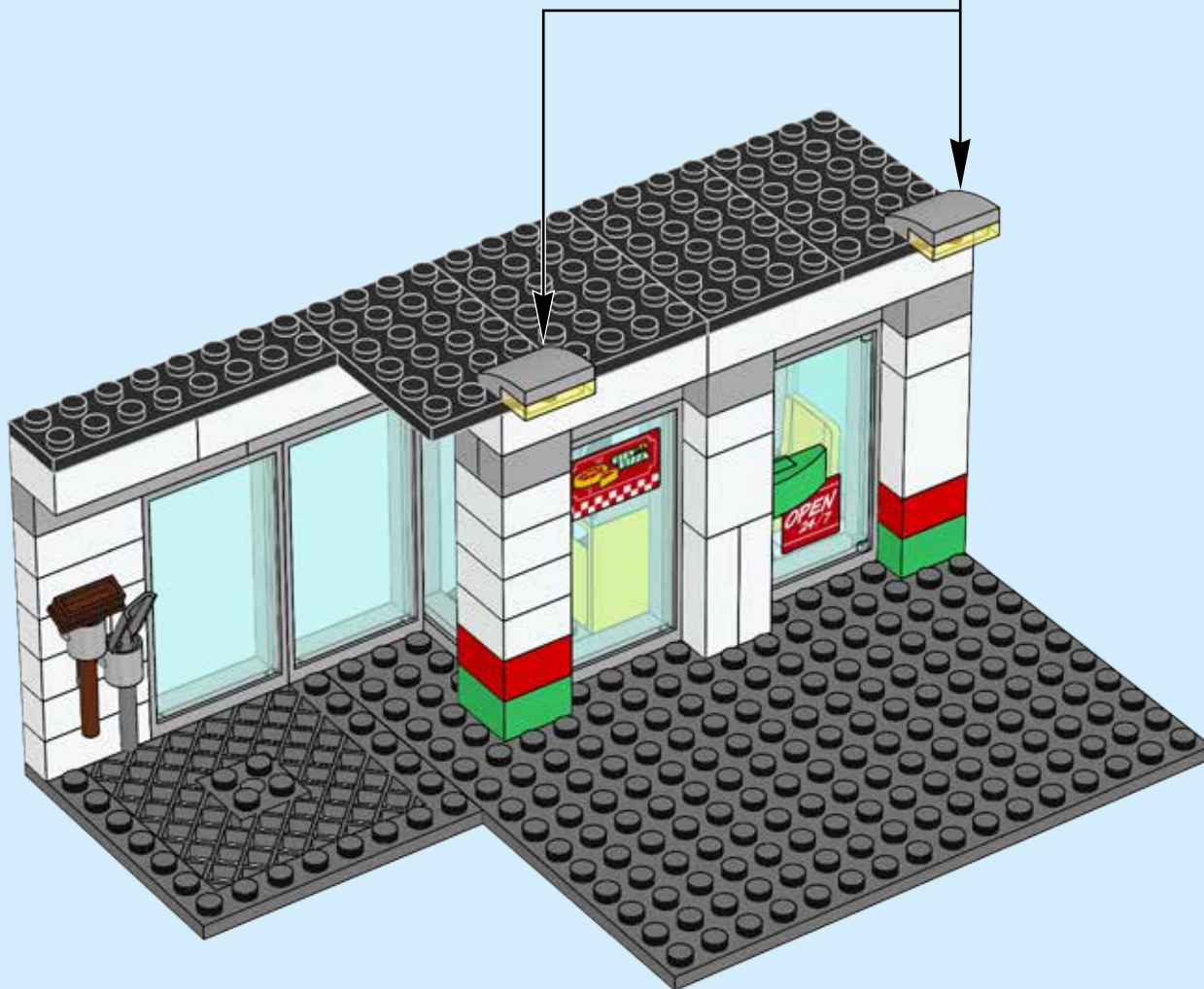
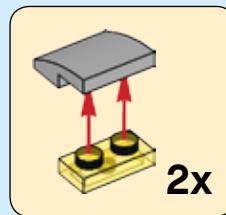

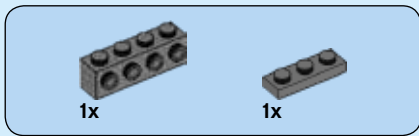

32

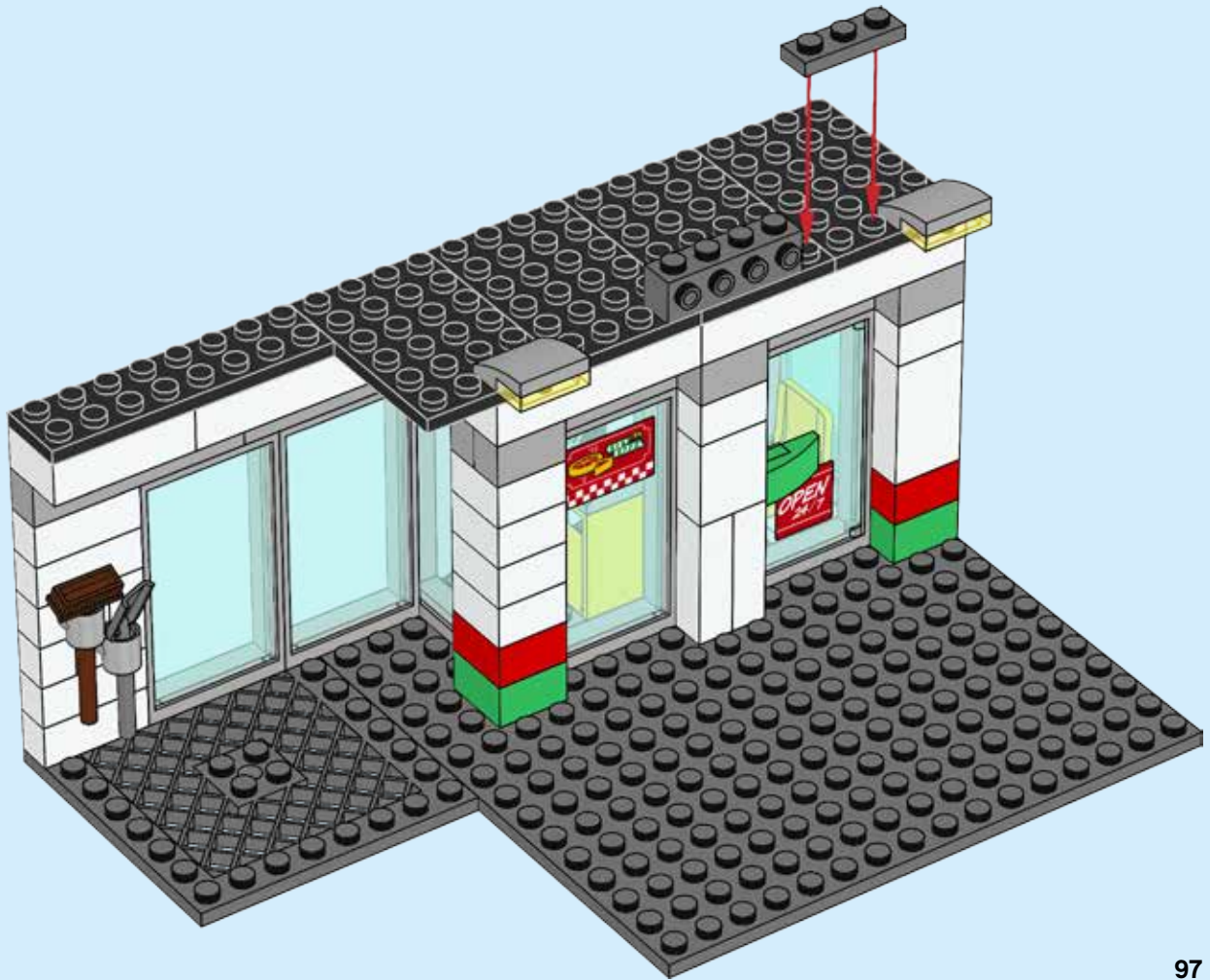

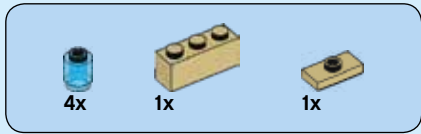

33

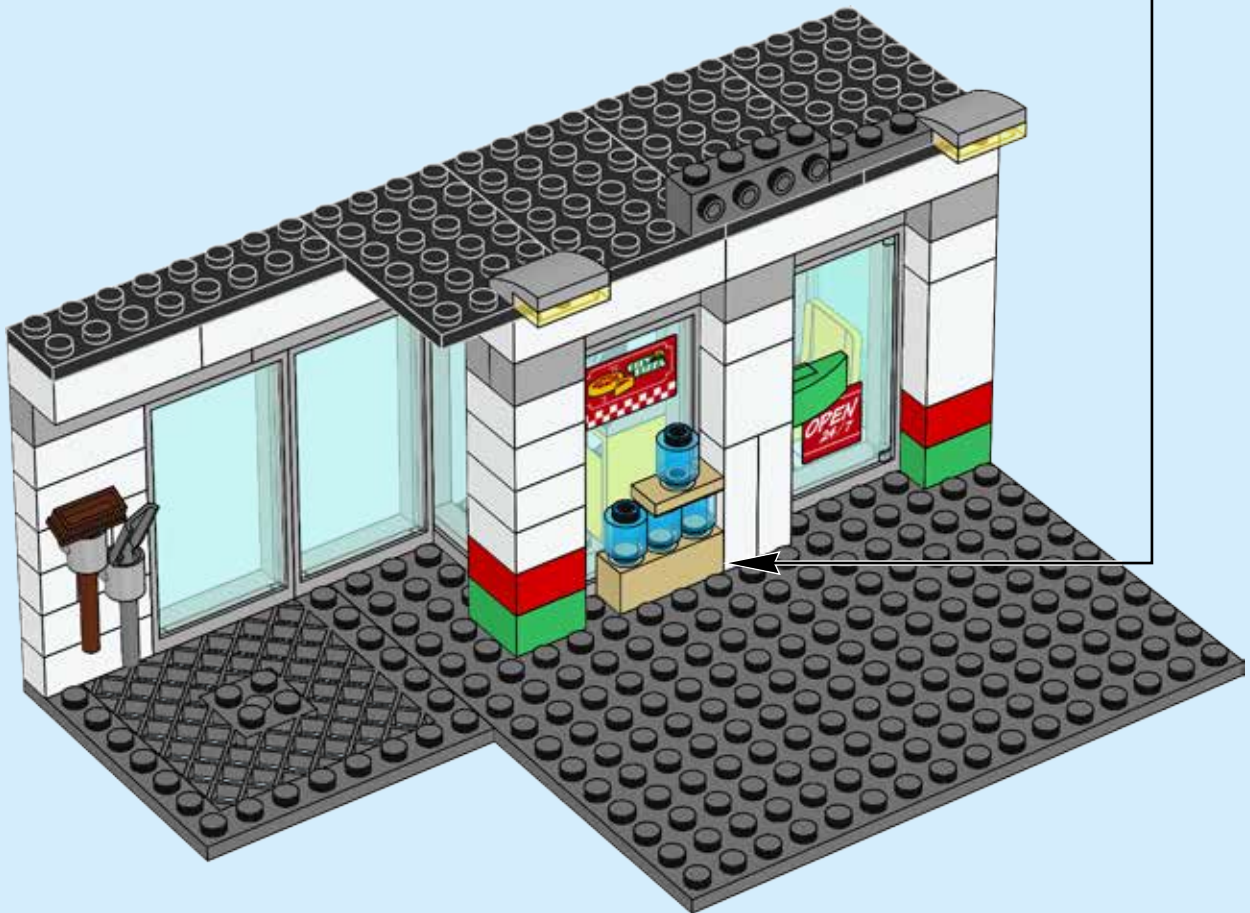
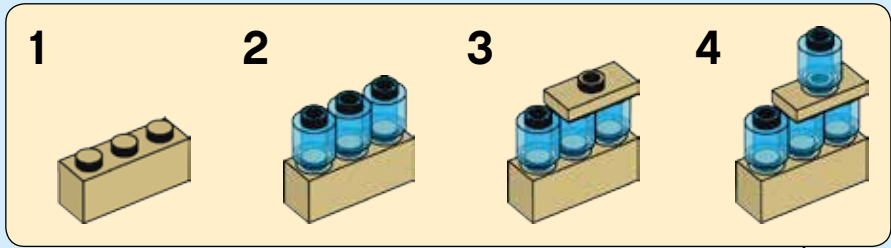

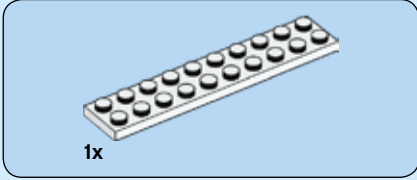

34

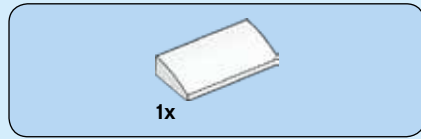
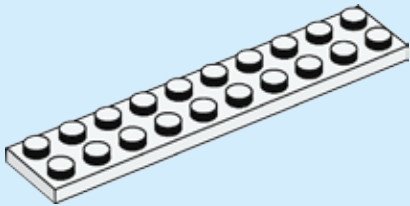

35

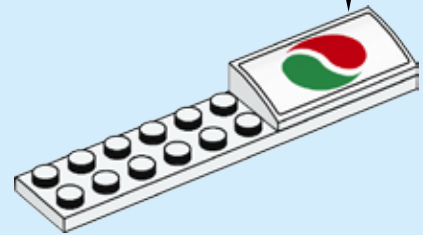
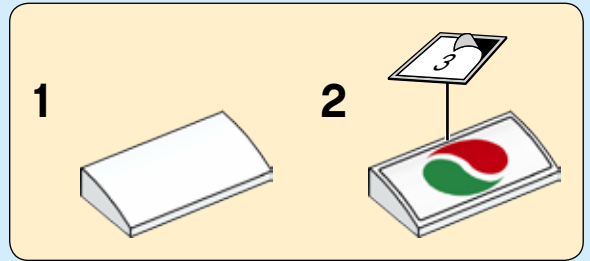

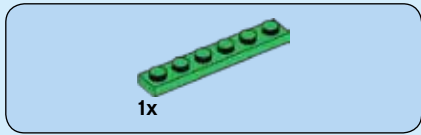

36

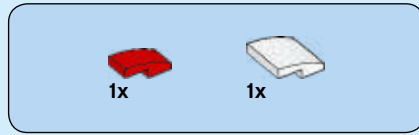
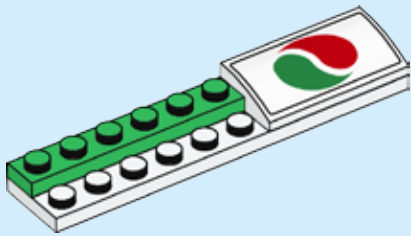

37

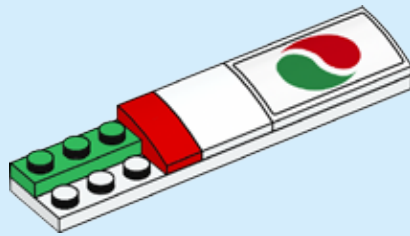

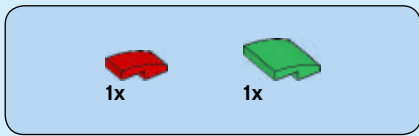

38

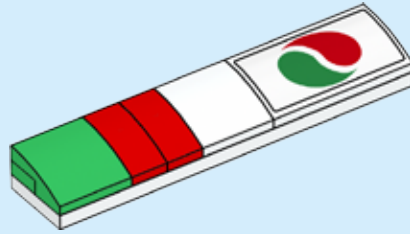

39



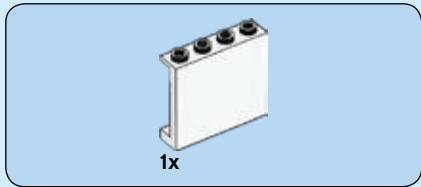

40

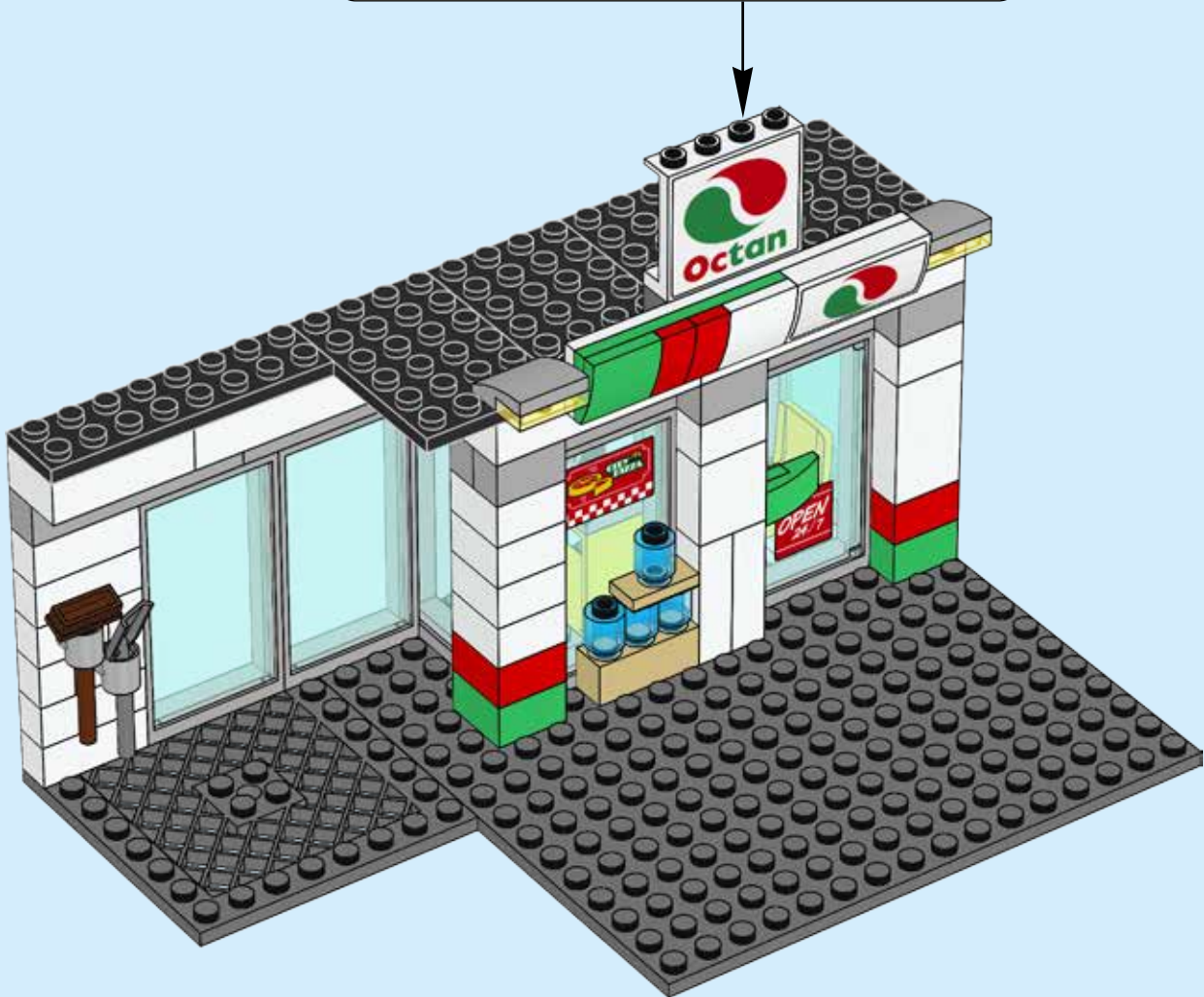
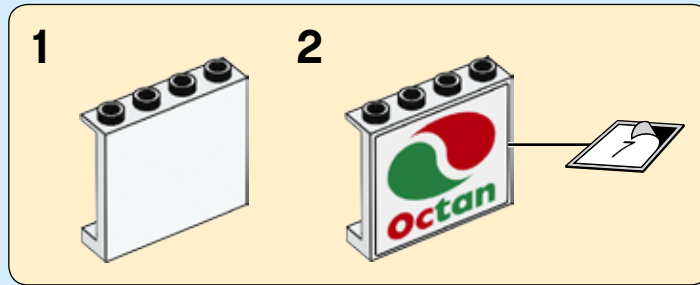

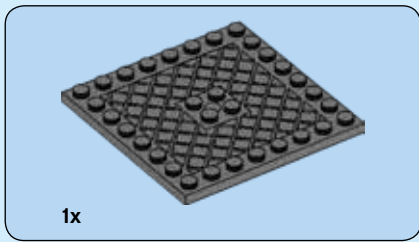

41



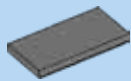

1x

42

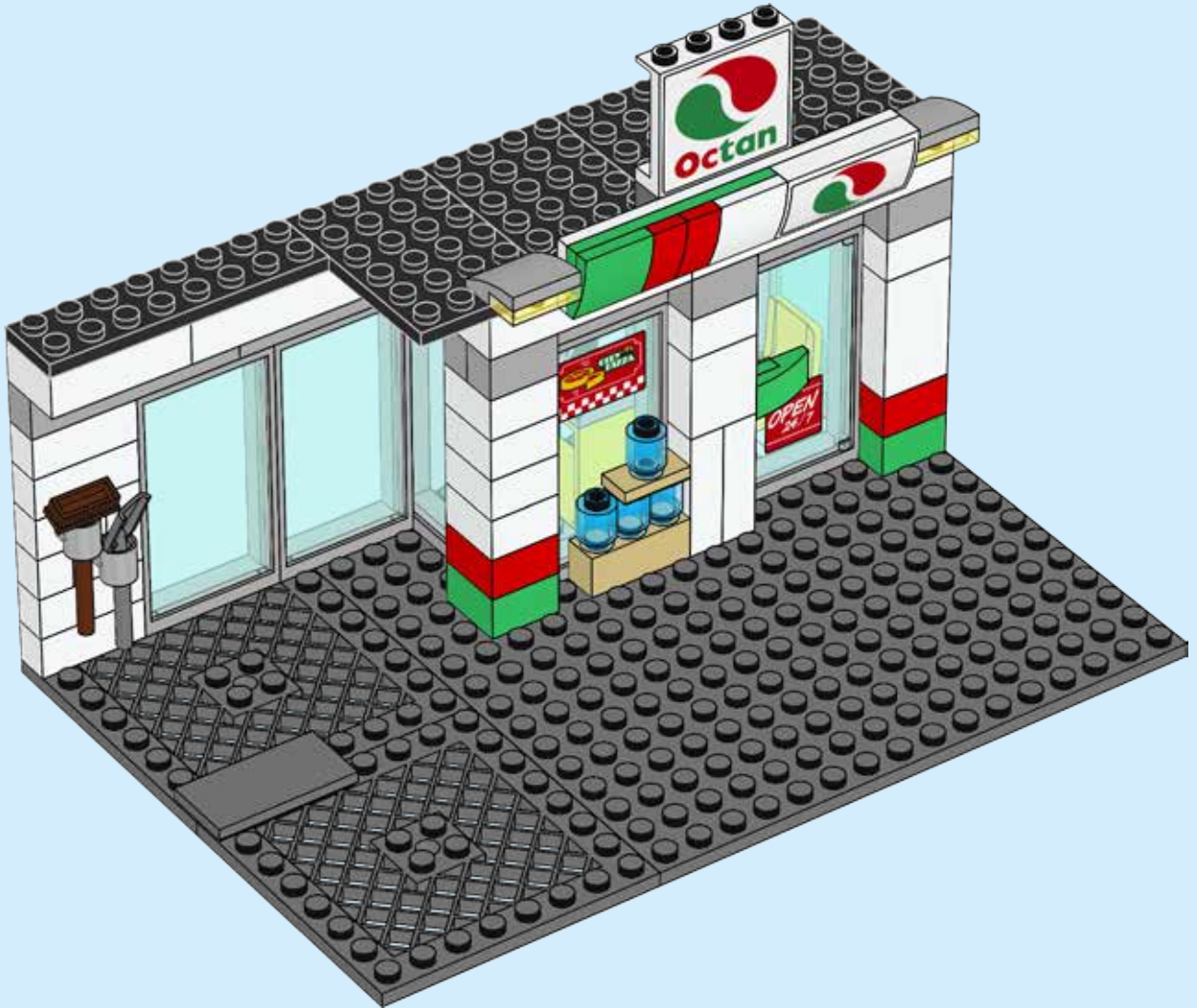

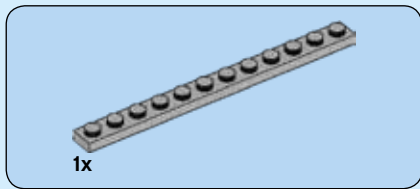

43



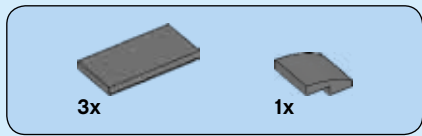

44





45

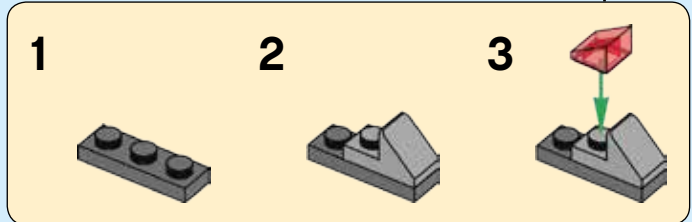

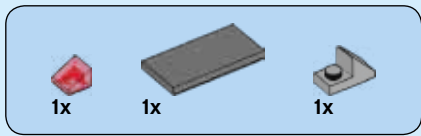

46



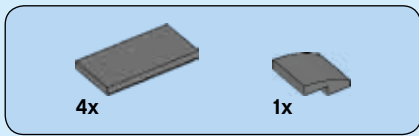

47

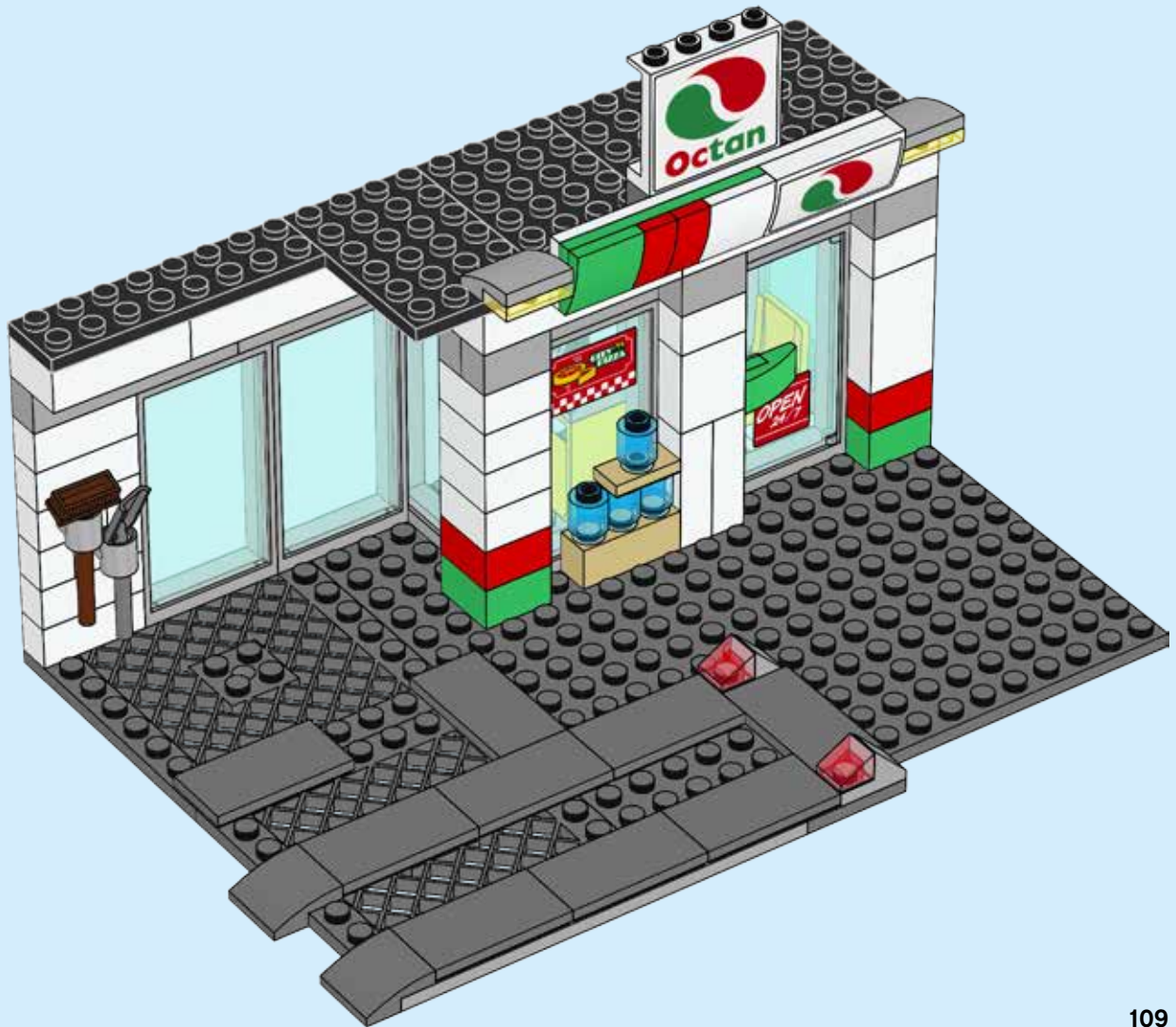

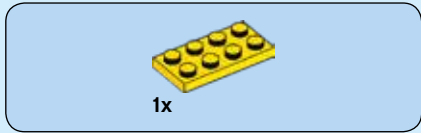

48

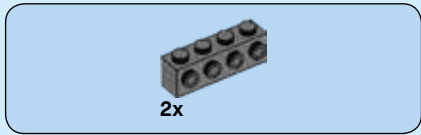
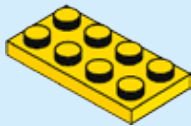

49

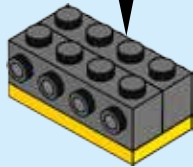
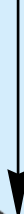
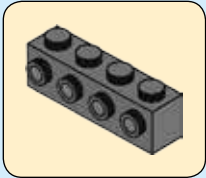



1x



2x

50

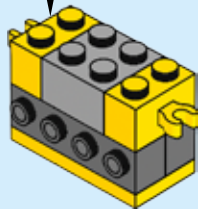
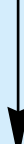
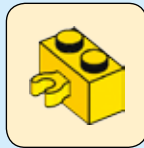

1x

51

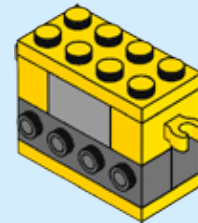

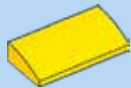

1x

52

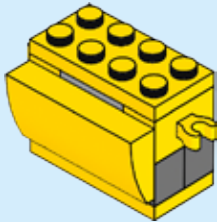

1x



1x

53



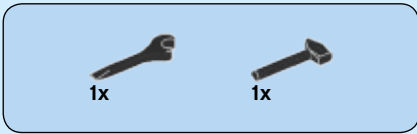

54



55

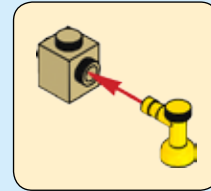

56





2x



1x

57



1

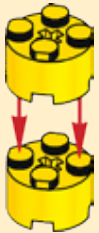

2



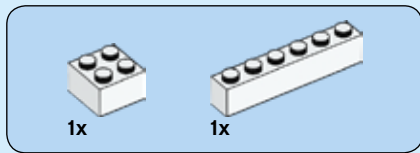

58

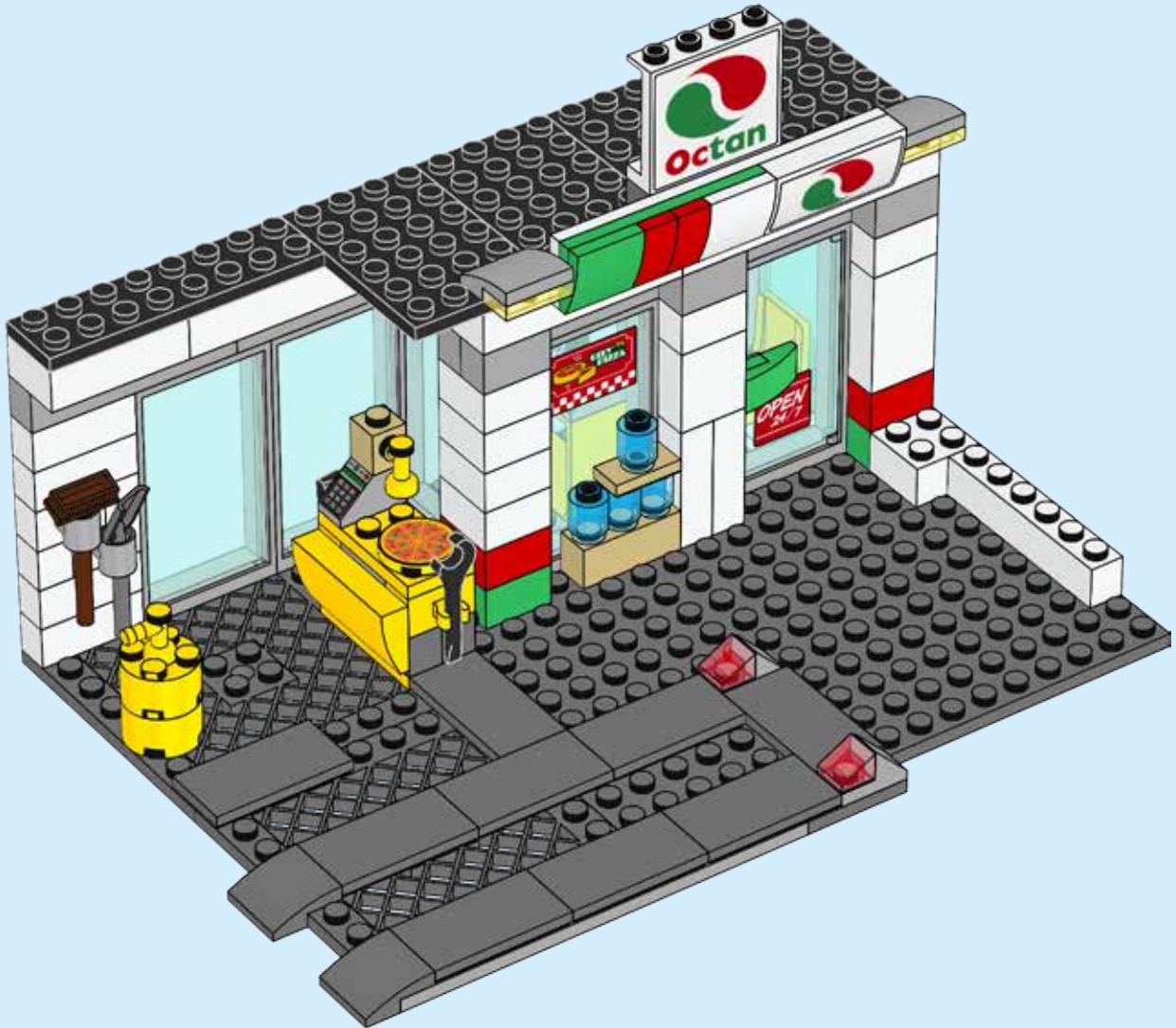

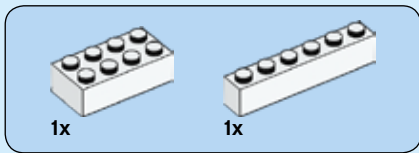

59

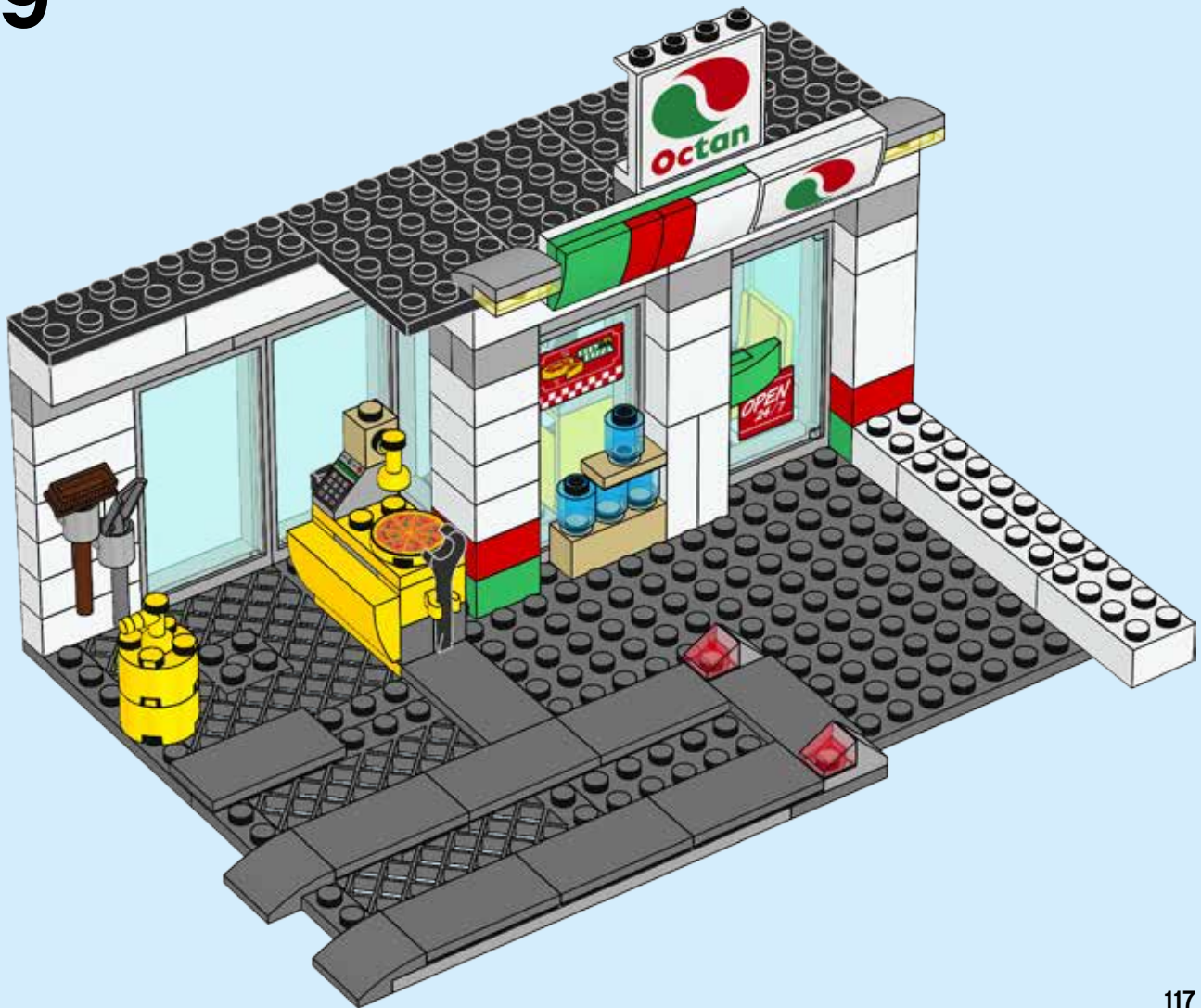

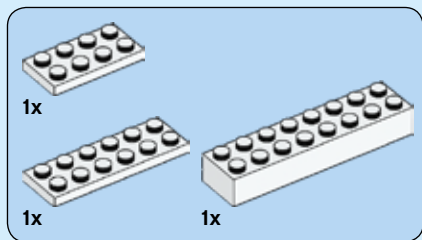

60

1

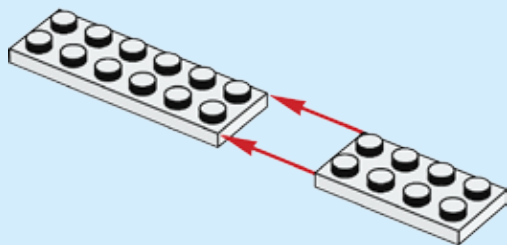

2

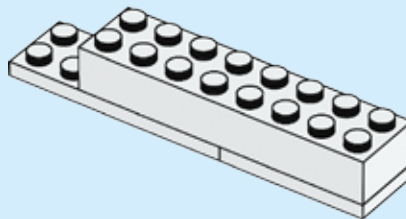

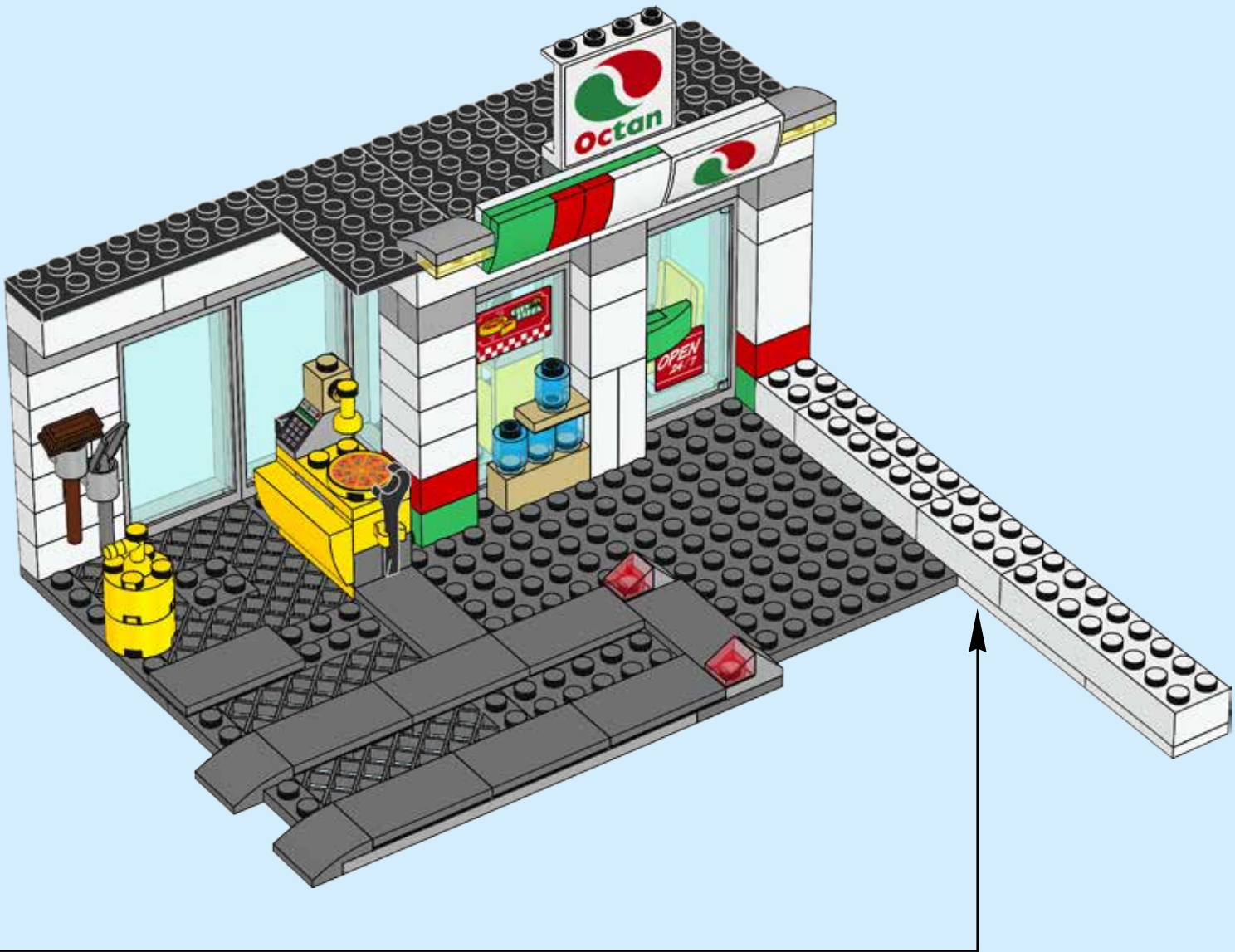

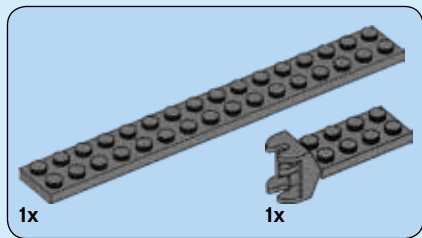

61

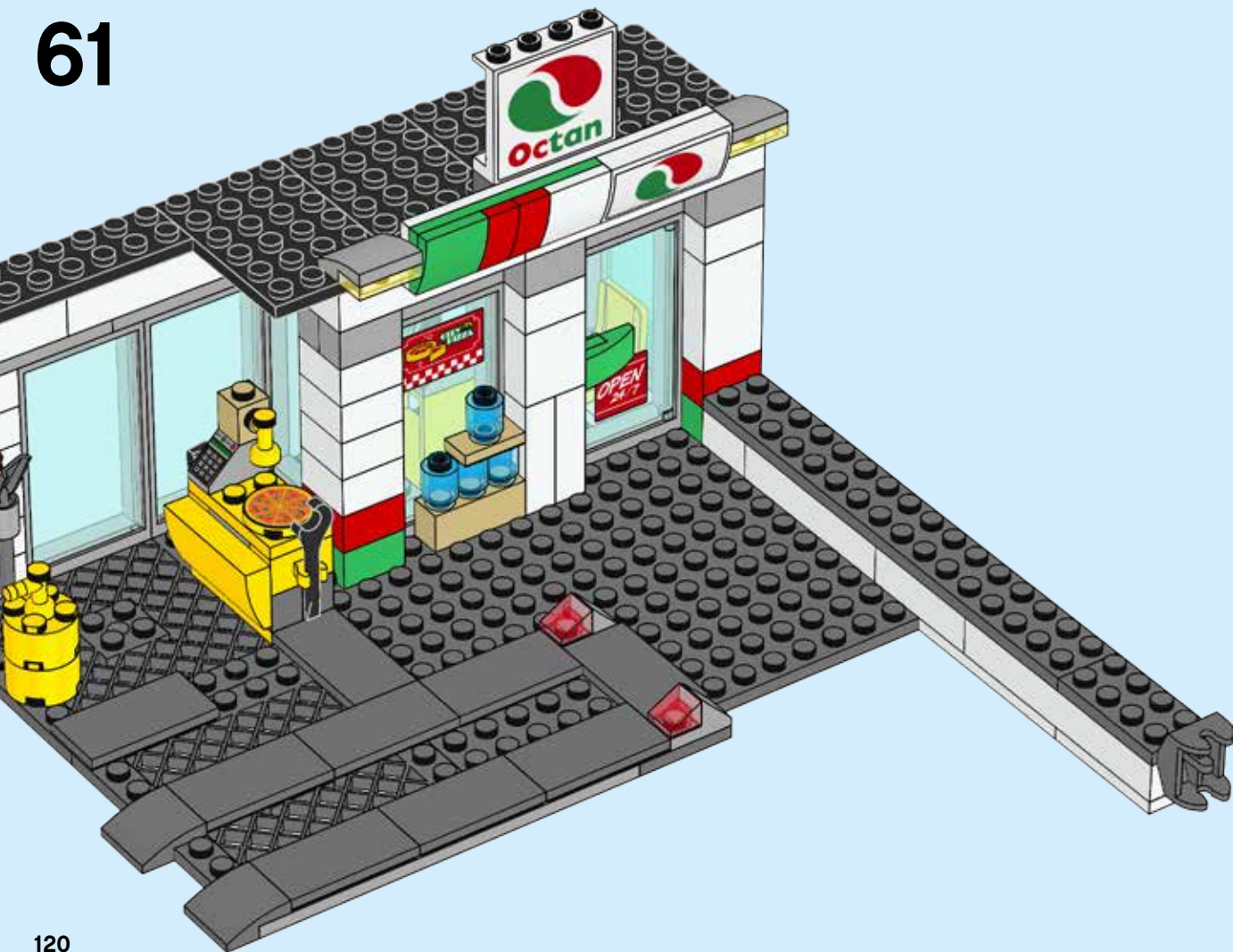



5x

62

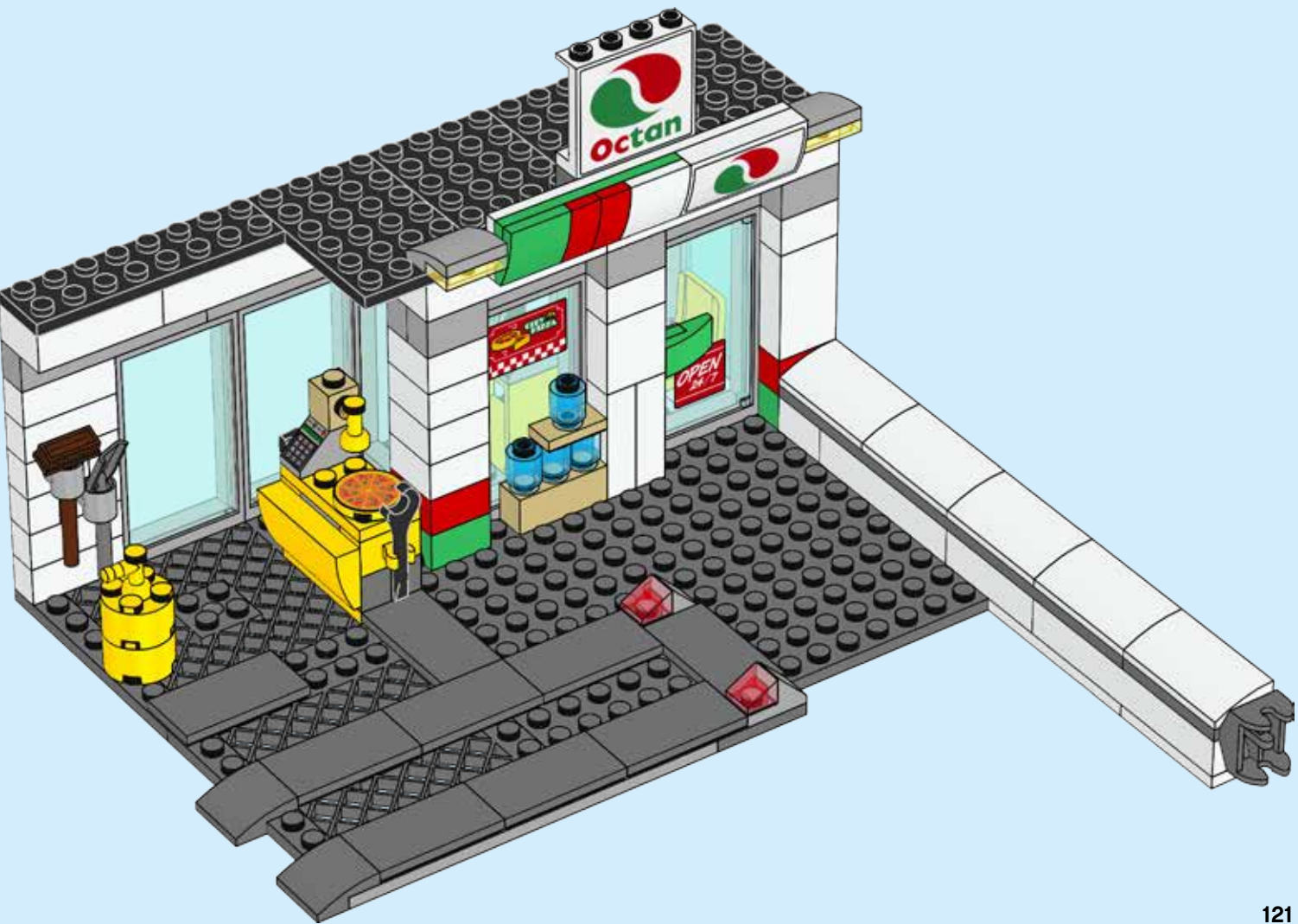

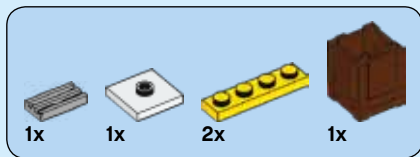

63

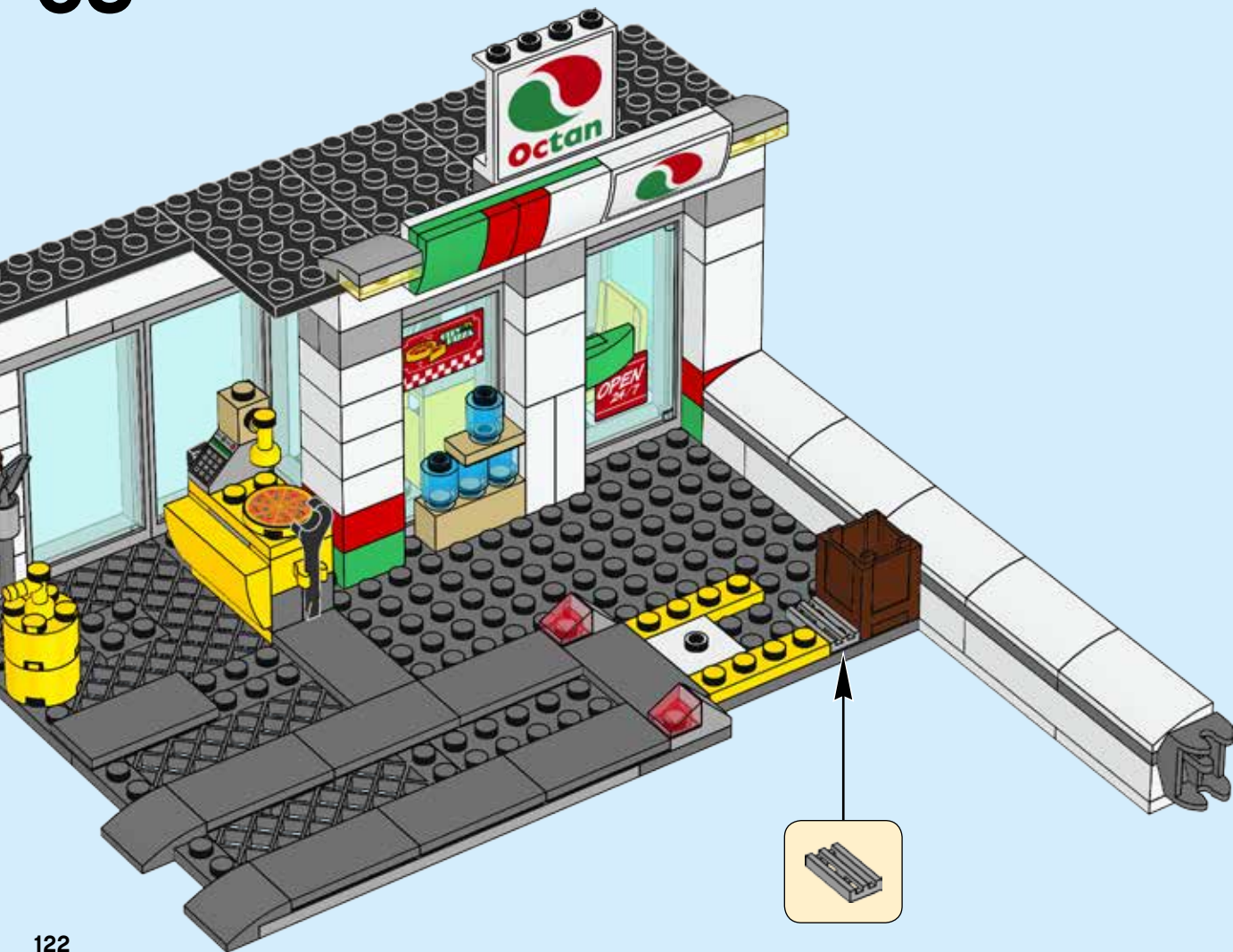

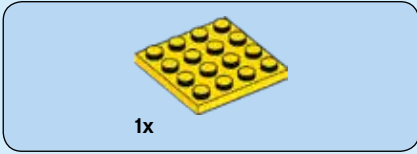

1x

64

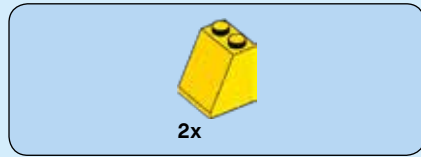
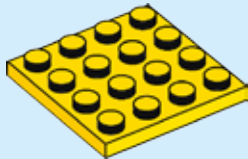

2x

65

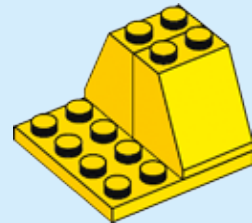



2x

66

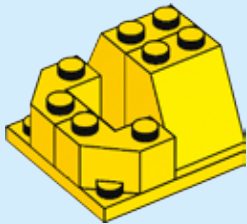

1x

67

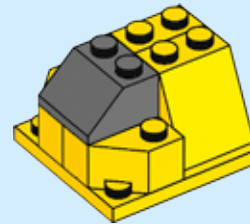

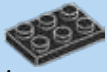

1x



1x



1x

68

1



2



3

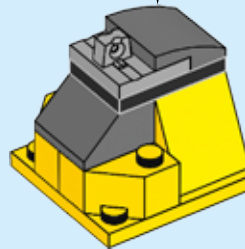

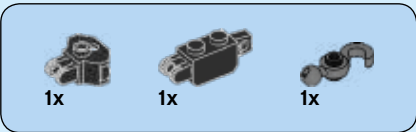

69

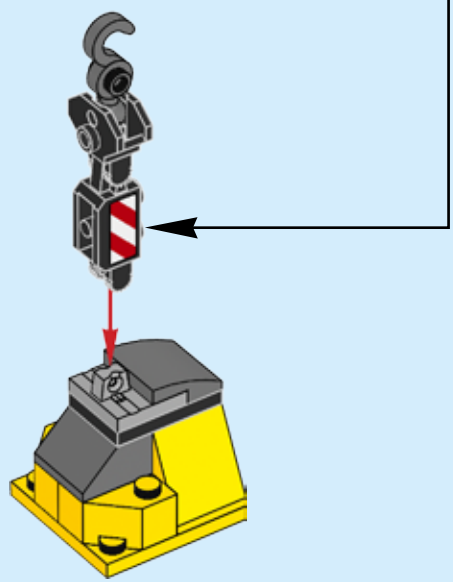
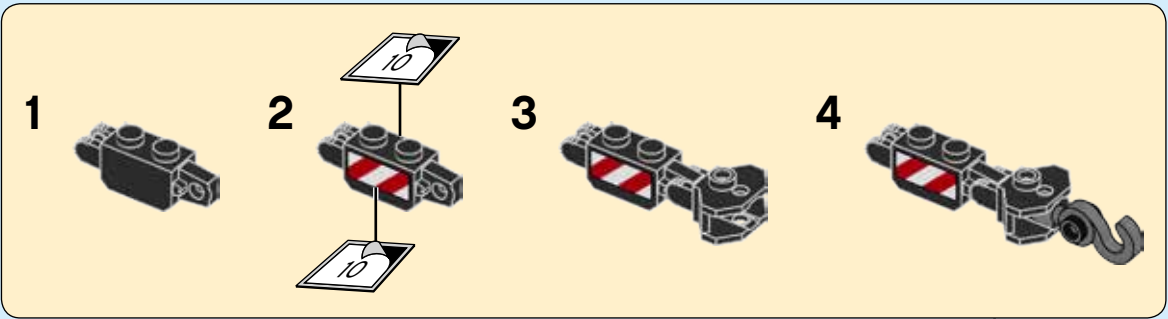

70

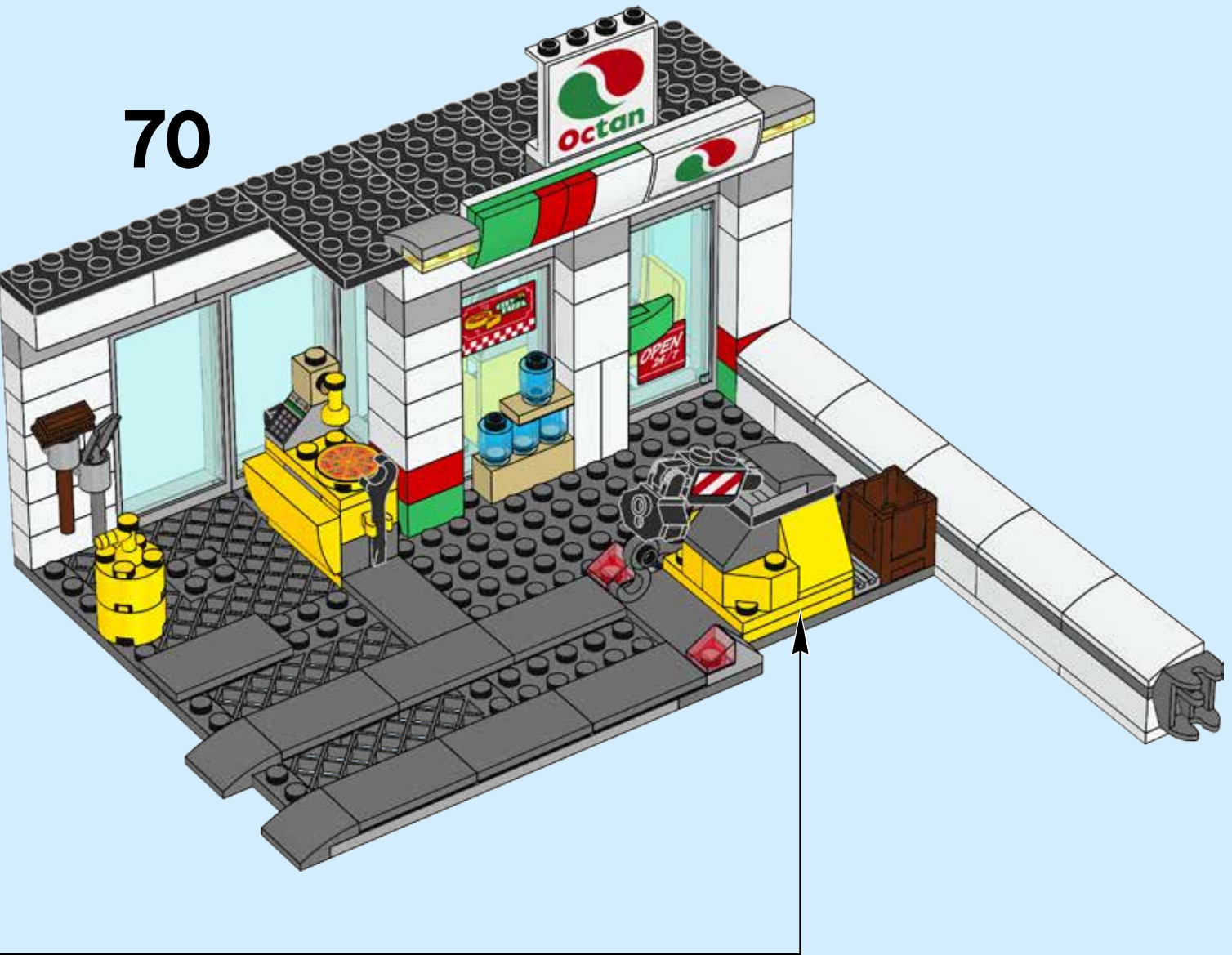

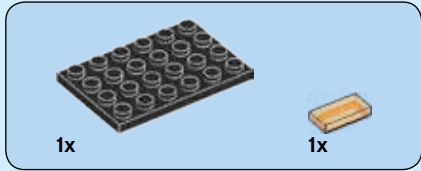
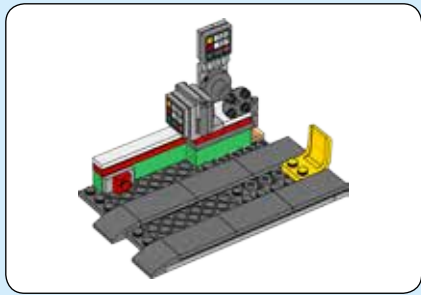

71

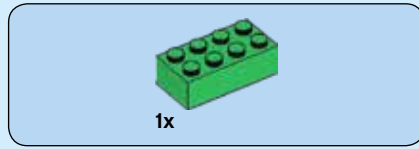
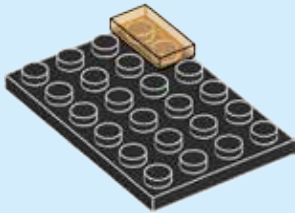

72

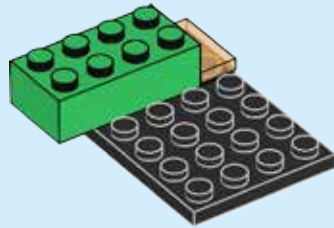

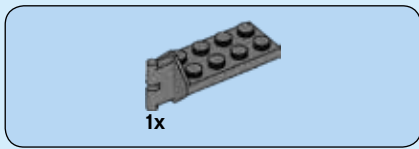

73

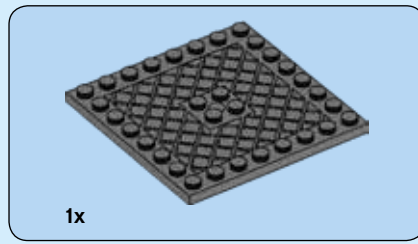
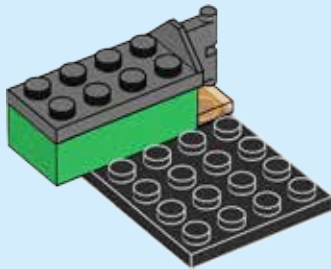

74

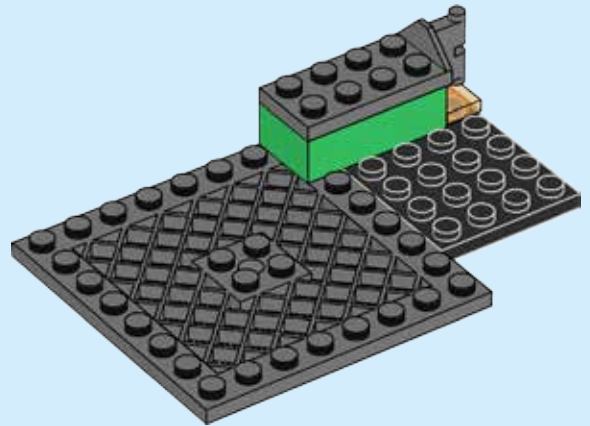



75

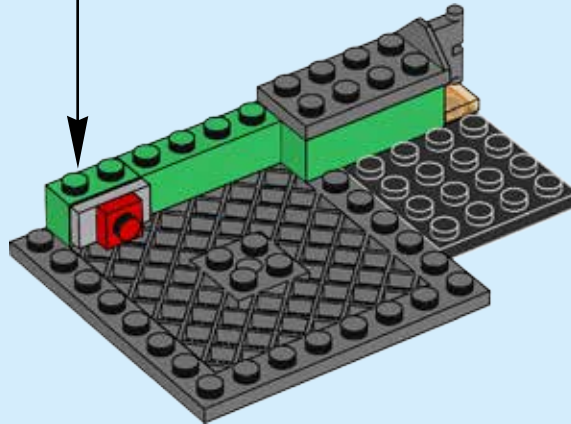
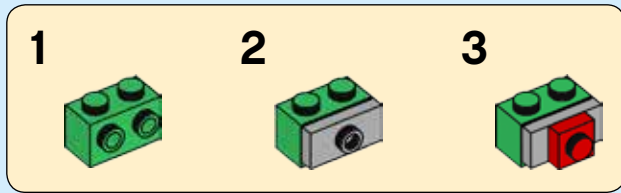

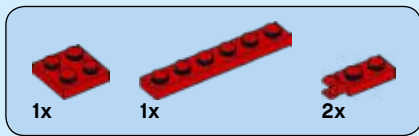

76

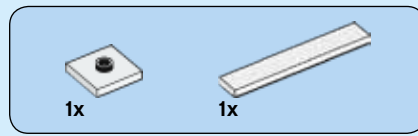
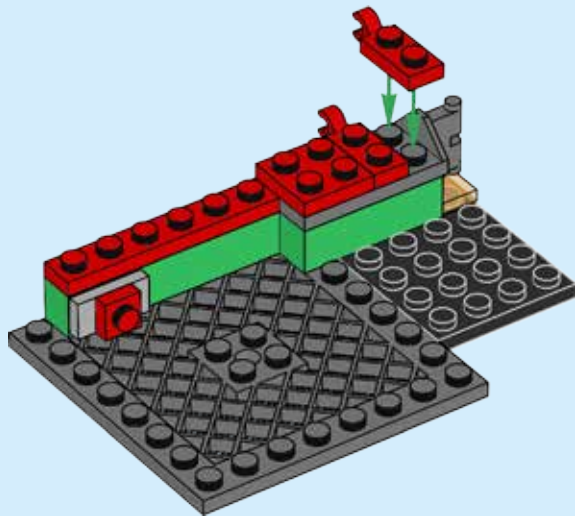

77

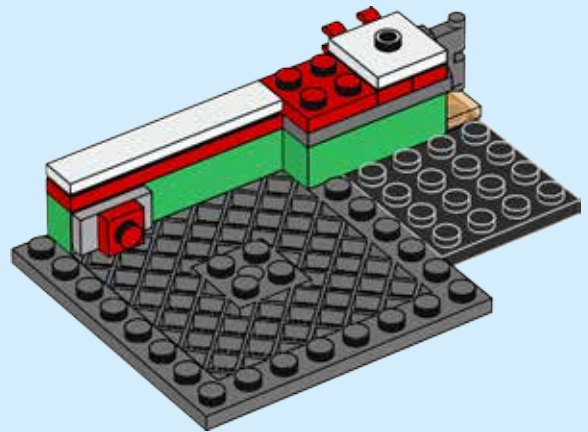

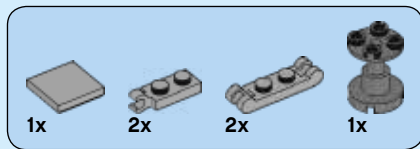

78

1

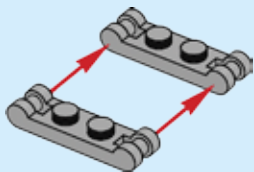

2



3

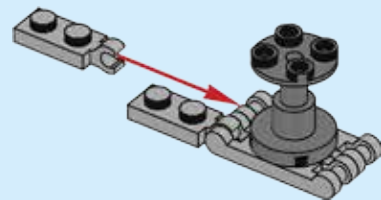

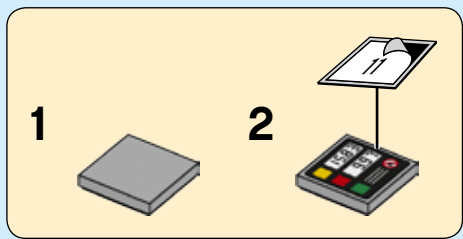

4

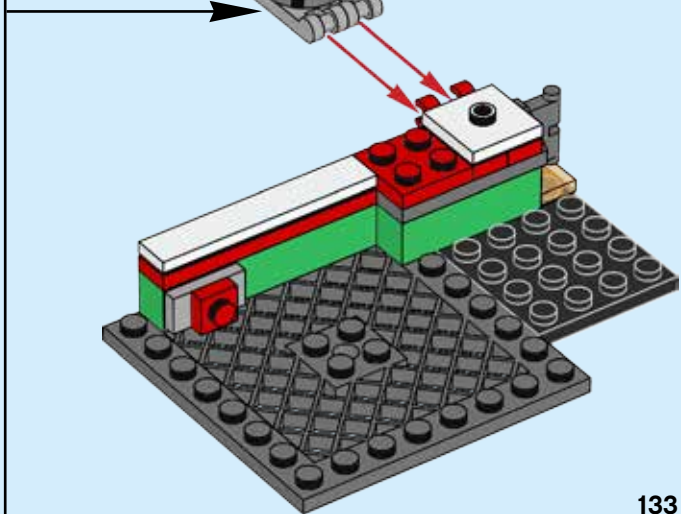
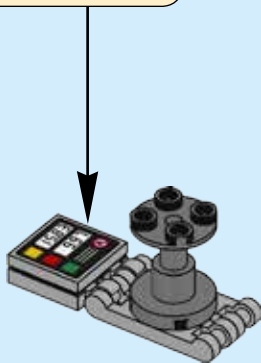

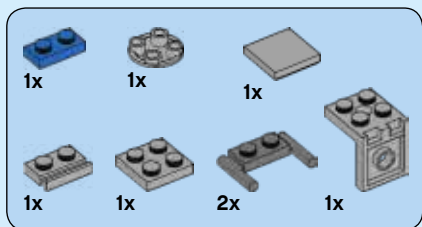

79

1



2



3



4

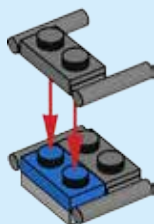

5

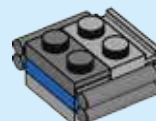

6

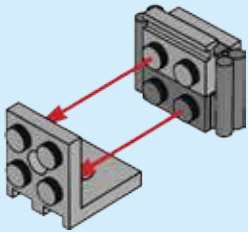

7

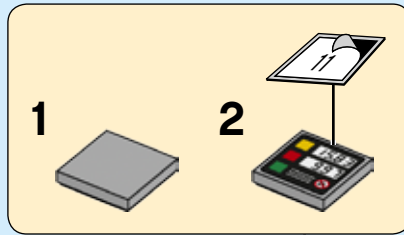

8

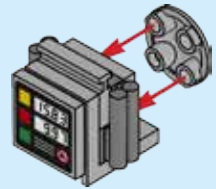

80

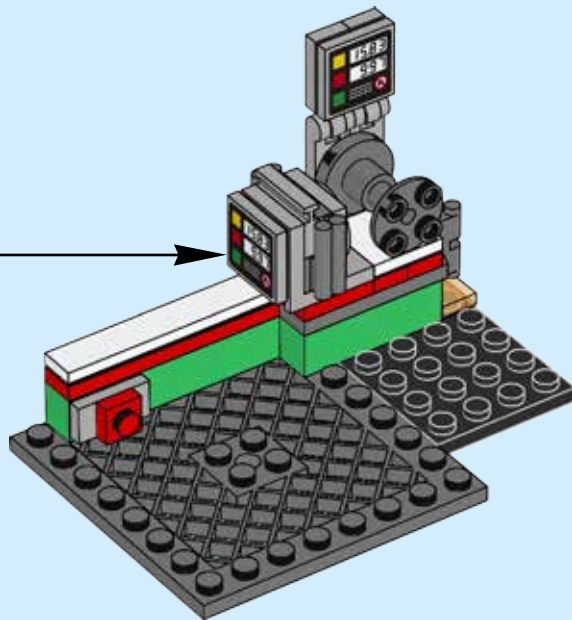

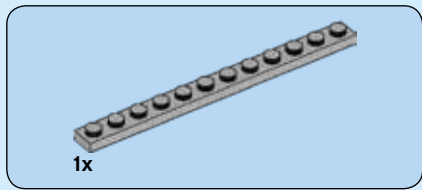

81

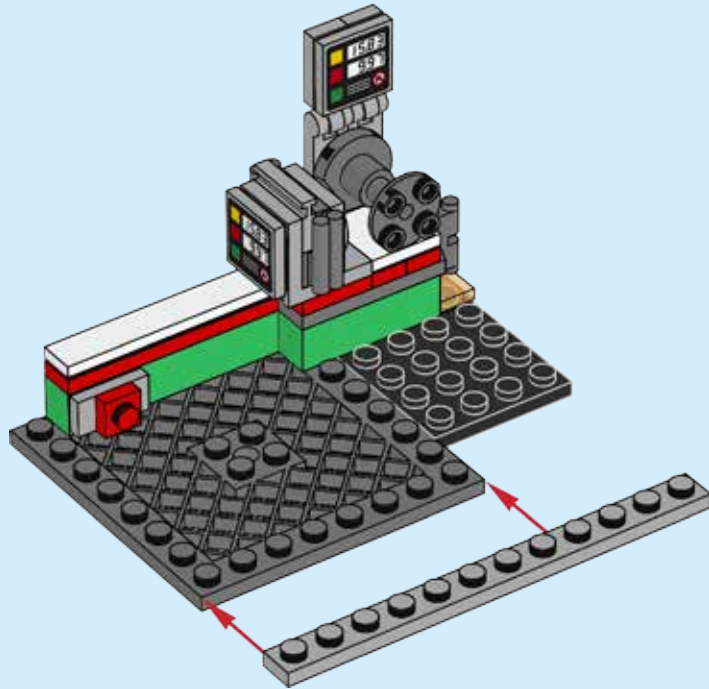



1x

82

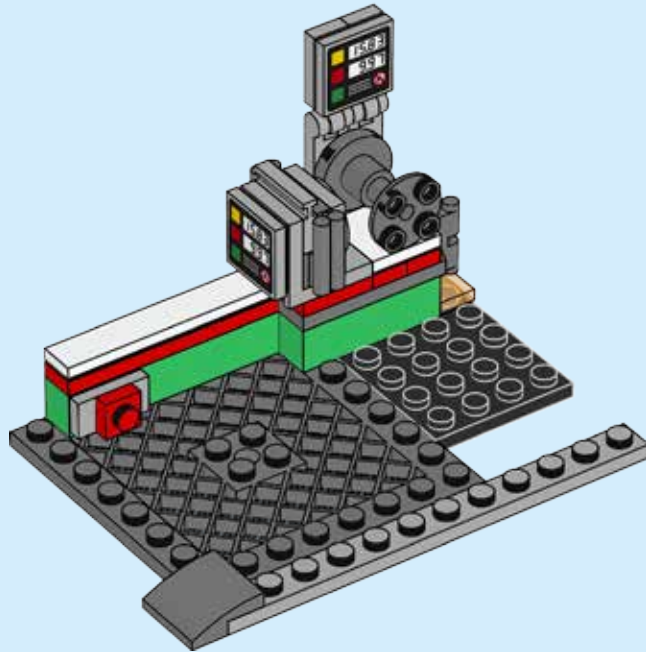



1x

83

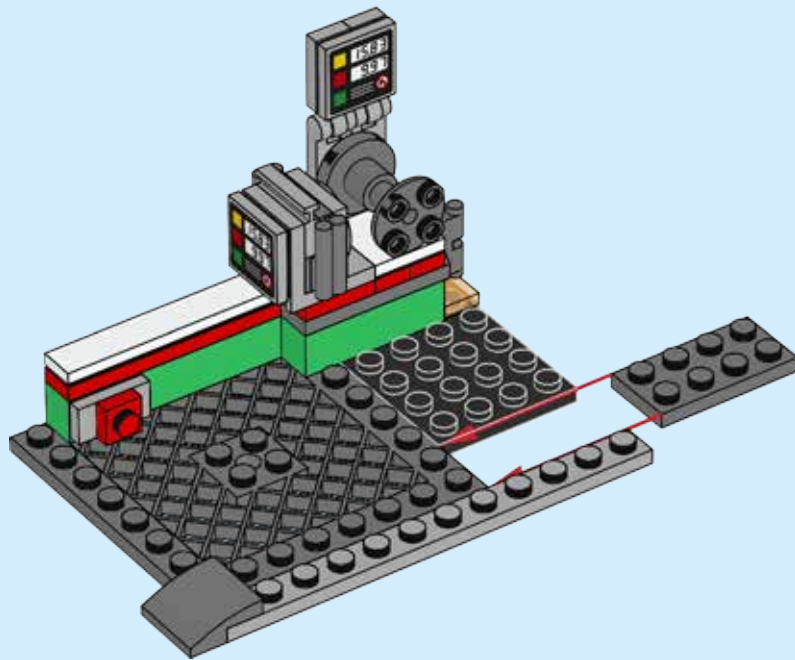

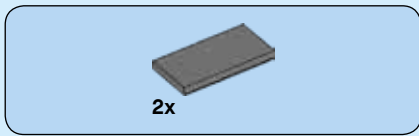

84

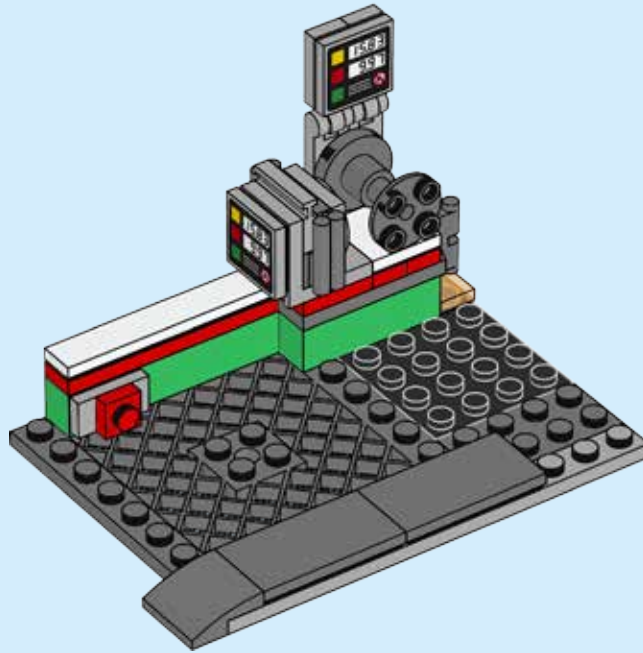

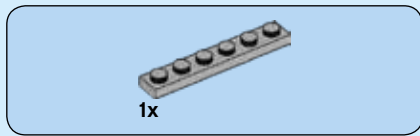

85

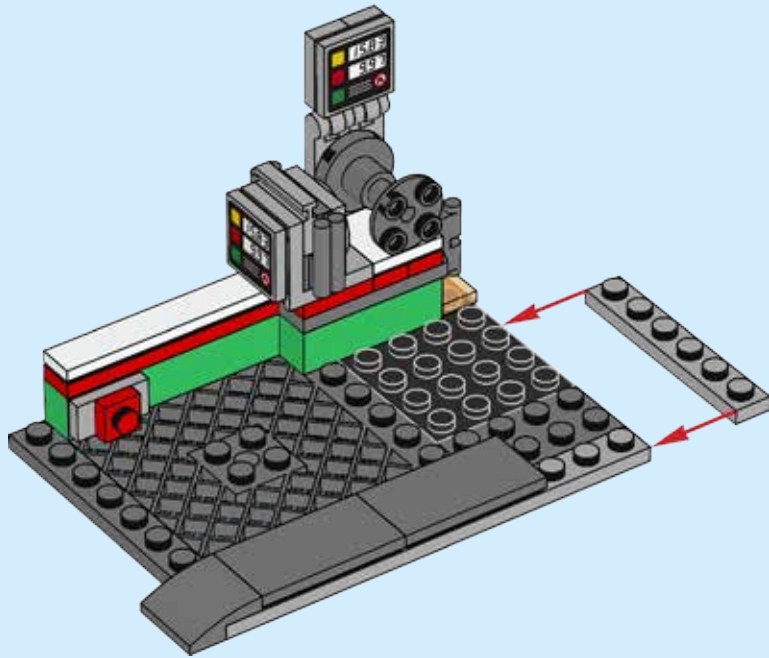

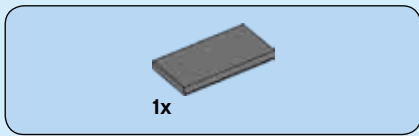

86

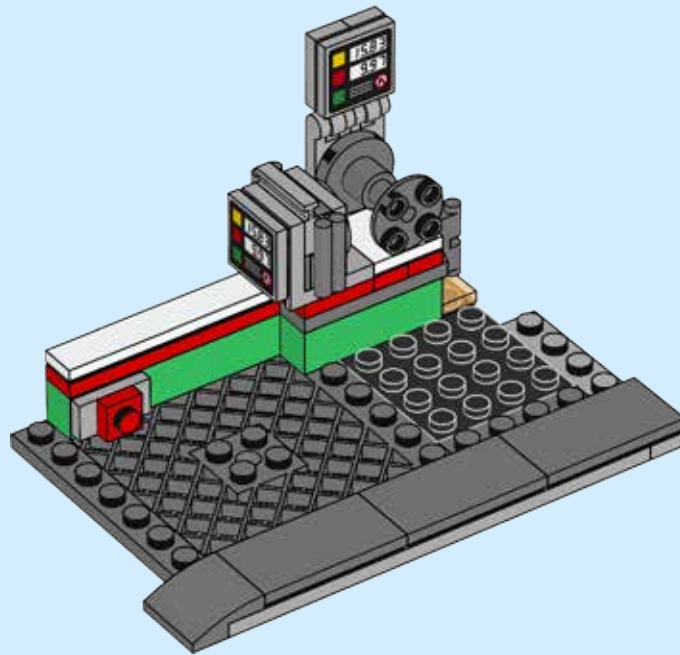

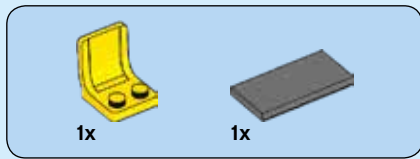

87

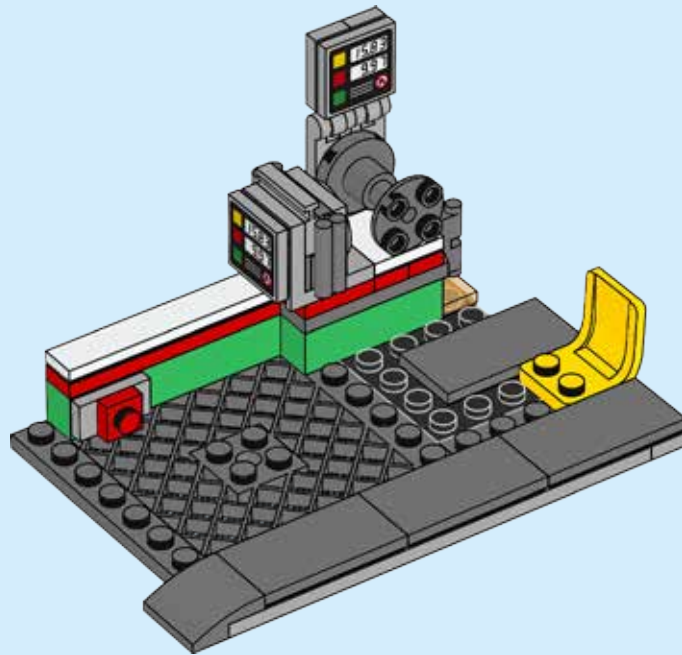

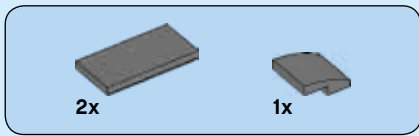

88

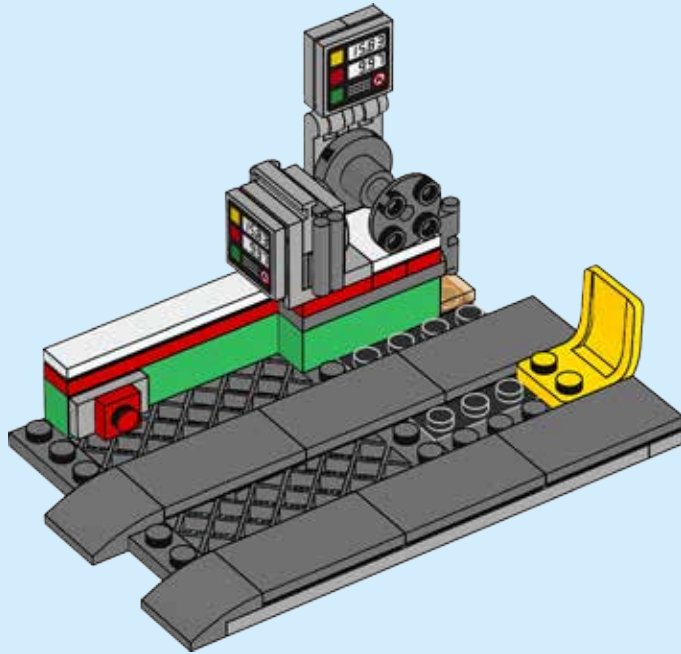

89

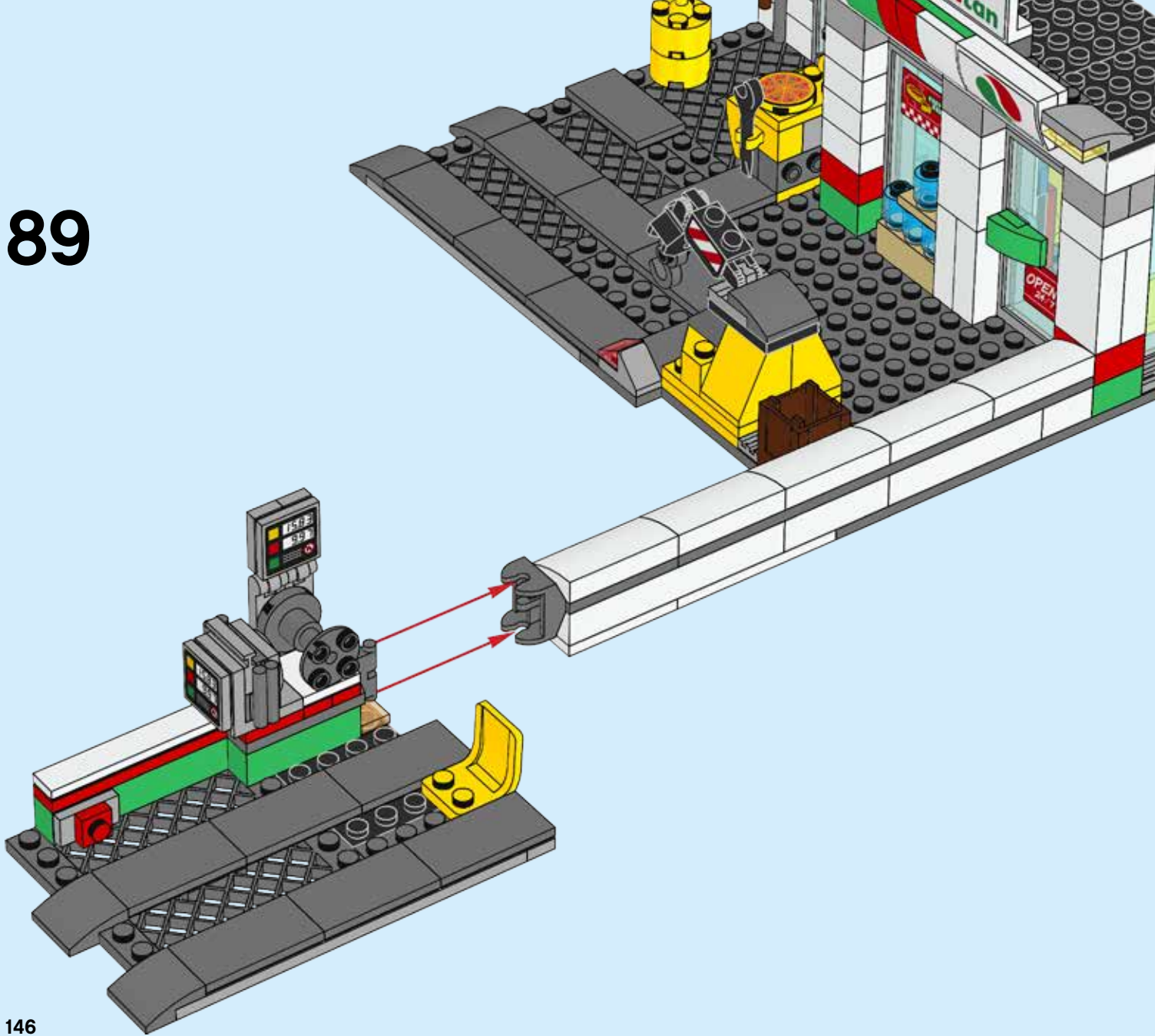





CITY



60141



60140



60139



60138



60137



60136



60135

 [LEGO.com/city](https://www.LEGO.com/city)